

**WFHSH**

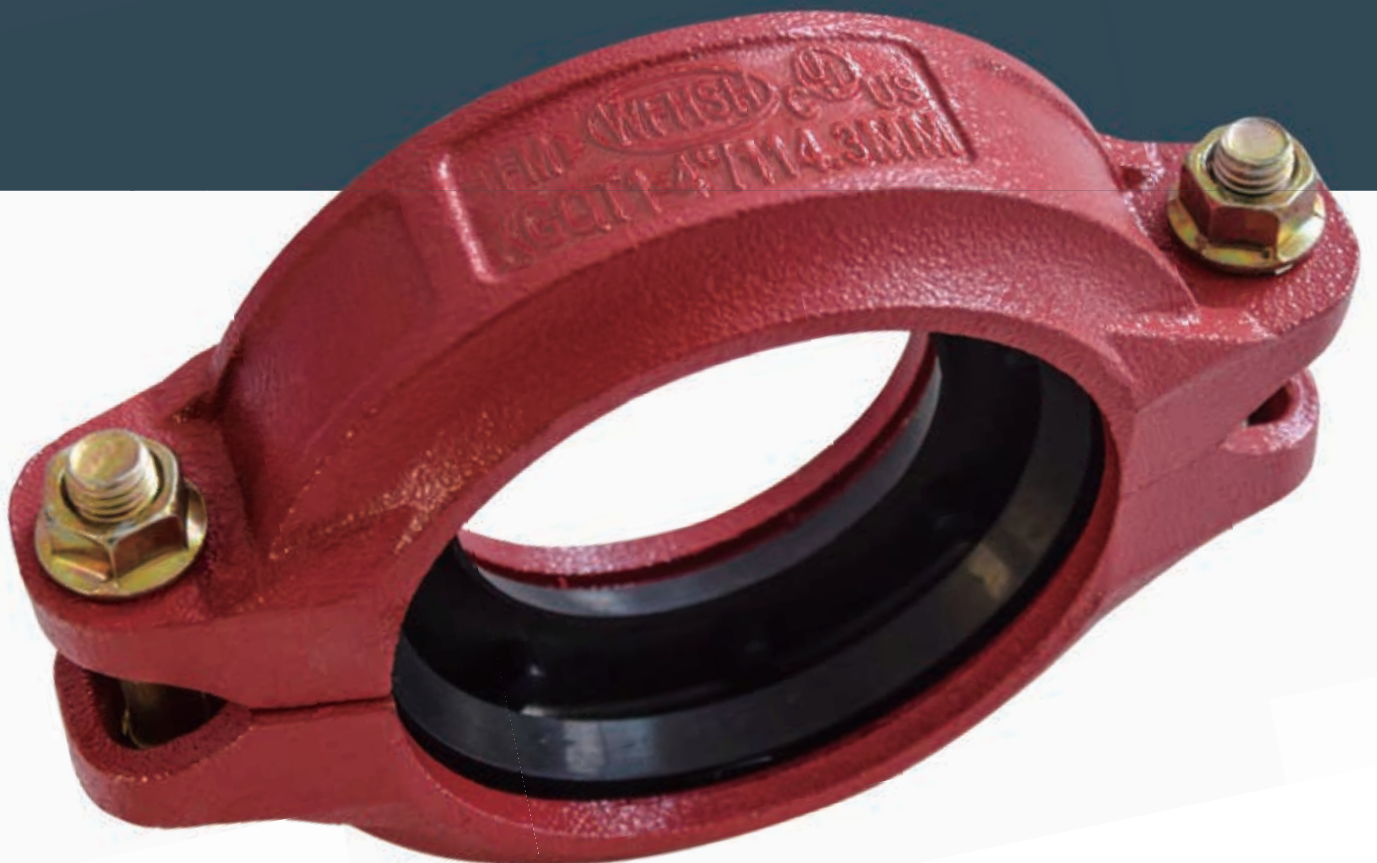

# GROOVED PIPE FITTINGS AND COUPLINGS



**SHANDONG ZHIHUA PIPE INDUSTRY CO.,LTD**

# President Speech

Initial stage of our history, we took an important role in development of early era of China industry by production of high quality Ductile Iron Grooved Pipe Fittings and Couplings. Through the years, we can accumulate know-how and knowledge which lead us to provide not only pipe system but also total fire fighting engineering solution about our specialized field to cooperation partner.

We are fulfilling customer's requirements by matching with specific fire fighting systems through 10 years relationship with valuable partners from all over the world.

Owing to superior quality products with engineering service and reliable business for a long time, we earn a good reputation from both customers and partners.

Customer's satisfaction is our top priority. Therefore, we focus to provide total solution to ensure responsibility together with after sales service. We believe that this is the reason why we realized as the fastest factory with fire fighting product in the industry.

we will be your right partner to make a reliable business in fire fighting industry. We will contribute all our efforts to the world fire safety.

President: Zhang Zhihua





# Company Profile

Shandong Zhihua Pipe Industry Co., Ltd, established in 2007, is specialized in Ductile Iron Grooved Pipe Fittings and Couplings for Fire Fighting. It's located in "World kite Capital" Weifang City known as Chinese Grooved Pipe Fittings production base and adjacent to Qingdao seaport.

Zhihua has passed ISO9001 quality management system and its grooved products have obtained FM&UL&CE approval and available for customer's OEM / ODM. Nowadays, the company owns two factories with 600 skillful workers and two brands: WFHSH®™&FANGAN®™, covering an area of 100000 square meter.

Zhihua has five main production workshops: Auto-casting workshop, Hand molding casting workshop, Machining workshop, Painting workshop and molding workshop. Zhihua factories are equipped with the most advanced facilities and equipment in the industry. The main production facilities contain 8 Chinese 416 automatic vertical molding production lines, automatic sand mixers, 6 Medium electric furnaces, 8 CNC molding machining centers, 2 Half auto sand molding casting machines, 50 CNC lathes for Thread&Groove, 2 electroplated coating lines, 2 epoxy&painting lines, which annual capacity has exceeded 60000 tons.

Zhihua is well-known and high reputation among customers for its faith, quality, price and service. Its grooved products are on sale all over 300 cities in China and exported to the United State, Middle East, South America, Southeast, Korea Ect.

A lot of things may change, but our commitment to professionalism, quality and customer service won't. Contact Zhihua to begin saving time and cost.





# Production Equipment

Sophisticated Equipment    Quality First







# Production Process



① Sand Mulling



② Melting



③ Pouring



⑥ Painting



⑤ End Grind Line



④ Shot Blasting



⑦ Pressure Test



⑧ Package



⑨ Warehouse



## Quality Control



- **Reliable Quality Assurance**

From incoming inspection to finished products, quality is checked and monitored in the whole process. Each step of the the manufacturing process is carefully documented, regularly reviewed for revision control and updating standard. Quality procedures are constantly monitored and updated to assure that only the highest and most consistent quality products are supplied to our valued customers.



- **Chemical Composition Inspection**

Zhihua laboratory has the most advanced and complete testing facilities, including iron quality controller, furnace analyzer, carbon sulfur analyzer, spectrometer, metallurgical microscope. There is a through quality control system with the laboratory that not only can quickly can correctly analyze composition of materials, bot also can control the composition on line during the production. Therefore, each various materials and grooved pipe fittings will be controlled by our strict requirement from the beginning to the end of the production.



- **Mechanical Property Test**

All the mechanical property tests of our products will be checked in our Mechanical Property Laboratory, regarding bolts and nuts, casting iron, steels, they will be tested from their stretch, compress, bend, tensile strength. They must be meet different standards for different application.





## ● Rubber Gasket Test

Rubber gasket is a very important part of grooved couplings. Its property will directly affect the security and service life of piping system. According to different materials of rubber gasket, first of all, we choose the most scientific formula and adopt most appropriate production process, and then, we will strictly do all the performance tests for each batch of the sealing rubber ring, including the hardness, strength, stretching rate, aging in hot air, oil resistance. The type of rubber gasket will be applied as a unit provided it has passed the test and met customer's requirement. The rubber gasket will keep the unchanging property with time going.



## ● Grooved Couplings and Fittings Test

We build the product testing laboratory according to the criteria of the standard of GB5135.11-2006&FM&UL&ISO. Therefore, we can do all the relative tests in our laboratory, including hydrostatic test, compress strength, withstanding seal, bending moment, rotating bend, vibration test, hot temperature resistance, low temperature resistance. The new products' appraisal type test, usual tests and performance inspection are also carried here. We make sure each order's complying with the relevant standards.



## Research&Development

### Product Design

The company has a strong product development and research team, the mold design is equipped with the most advanced 3D design software, all molds are designed by CAD/CAM computer aided system, product structure optimization based on finite element theory, fully consider the possible production defects in the casting process, the design safety factor of the product is closer to the actual production.

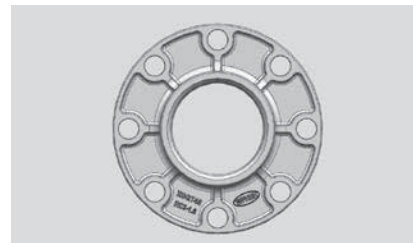
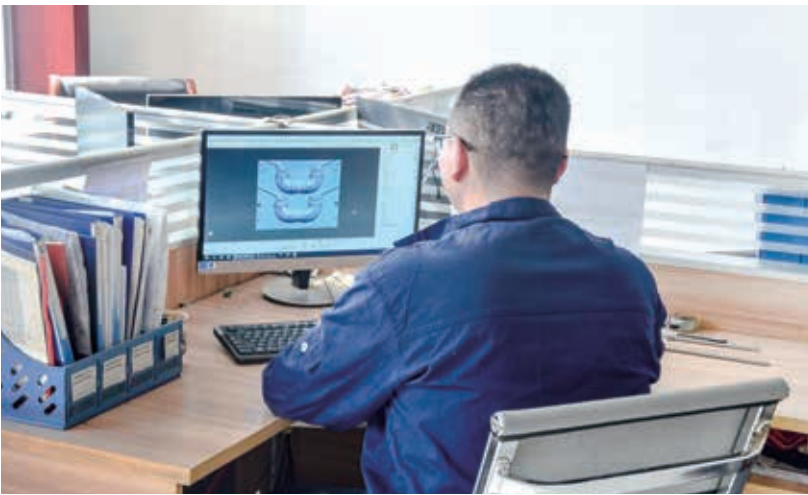

### Mould Manufacturing

The company has a strong product development and research team, the mold design is equipped with the most advanced 3D design software, all molds are designed by CAD/CAM computer aided system, product structure optimization based on finite element theory, fully consider the possible production defects in the casting process, the design safety factor of the product is closer to the actual production.





# Certificates



ZHIHUA FM Gasketed Certificate



ZHIHUA FM Non Gasket Certificate

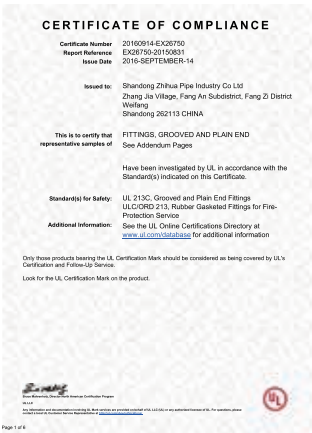

ZHIHUA UL EX26750Certificate



PICC



CCC

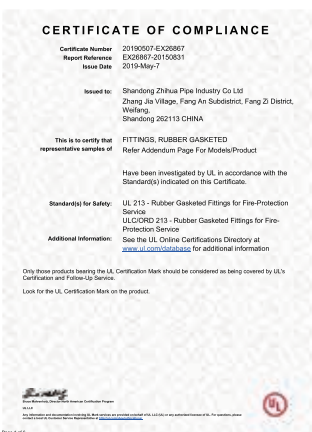

ZHIHUA UL EX26867Certificate



GN201606971



ISO14001

# Product Gallery

Material: ASTM A536 GRADE 65-45-12, QT450-10

Threads: ASME b1.20.1, ISO 7-1, GB7306

Size Available: 1" - 12"

Surface Treatment:

P: Painted E: Electroplated S: Epoxy G: Hot-dip Galvanized

Available Color: Red Orange Blue Gray White



**XGQT1**  
Rigid Coupling



**XGQT1N**  
Flexible Coupling



**XGQT2**  
Angle pad Coupling



**XGQT1B**  
Flexible Reducing Coupling



**XGQT08**  
Grooved Split Flange



**XGQT3**  
Grooved Mechanical Tee



**XGQT3S**  
Threaded Mechanical Tee



**XGQT3U**  
U-bolted Threaded Mechanical Tee



**XGQT01**  
90° Elbow



**XGQT02**  
45° Elbow



**XGQT09**  
22.5° Elbow



**XGQT9**  
11.25° Elbow





XGQT07

Equal Cross



XGQT7

Grooved Reducing Cross



XGQT7S

Threaded Reducing Cross



XGQT06

End Cap



XGQT5

Grooved Concentric Reducer



XGQT5S

Threaded Concentric Reducer



XGQT05

Grooved Eccentric Reducer



XGQT03

Equal Tee



XGQT04

Grooved Reducing Tee



XGQT04S

Threaded Reducing Tee



XGQT8

Adaptor Flange

## Product Application

- 1)Automatic sprinkler system for fire protection on commercial ,civil and municipal constructions like water supplying ,gas supplying, heat supplying,etc
- 2)Industrial pipeline system on shipping ,mine, oil field,textile,powder plant,etc.
- 3)Pipeline system on subway station ,railway station ,airport, seaport,bridge,etc



## XGQT1 Rigid Coupling

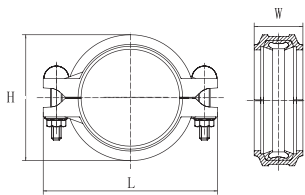

Nominal Size mm/in	Pipe O.D mm	Working Pressure PSI/Mpa	Dimensions mm			Bolt Size NO.-Size mm	Certificate
			L	H	W		
25/1	33.7	300/2.07	97	58	45.5	M10x45	FM UL
32/1¼	42.4	300/2.07	104	66	45.5	M10x45	FM UL
40/1½	48.3	300/2.07	114	72	45.5	M10x45	FM UL
50/2	60.3	300/2.07	128	85	45.5	M10x55	FM UL
65/2½	73.0	300/2.07	137	94	45.5	M10x55	FM UL
65/2½	76.1	300/2.07	142	98	45.5	M10x55	FM UL
80/3	88.9	300/2.07	164	112	46	M12x65	FM UL
100/4	108.0	300/2.07	187	134	50	M12x65	FM UL
100/4	114.3	300/2.07	190	138	50	M12x65	FM UL
125/5	133.0	300/2.07	212	160	50	M12x75	FM UL
125/5	139.7	300/2.07	223	168	50	M12x75	FM UL
125/5	141.3	300/2.07	226	170	50	M12x75	FM UL
150/6	159.0	300/2.07	244	188	50	M12x75	FM UL
150/6	165.1	300/2.07	247	194	50	M12x75	FM UL
150/6	168.3	300/2.07	250	196	50	M12x75	FM UL
200/8	219.1	300/2.07	320	254	60	M16x90	FM UL
250/10	273.0	300/2.07	408	316	65	M20x120	FM UL
300/12	323.9	300/2.07	460	372	65	M22x140	FM UL

## XGQT1N Flexible Coupling

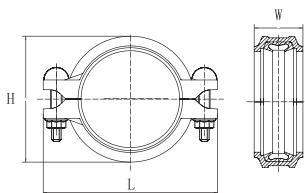

Nominal Size mm/in	Pipe O.D mm	Working Pressure PSI/Mpa	Dimensions mm			Bolt Size NO.-Size mm	Certificate
			L	H	W		
25/1	33.7	300/2.07	97	58	45.5	M10x45	FM UL
32/1¼	42.4	300/2.07	104	66	45.5	M10x45	FM UL
40/1½	48.3	300/2.07	114	72	45.5	M10x45	FM UL
50/2	60.3	300/2.07	128	85	45.5	M10x55	FM UL
65/2½	73.0	300/2.07	137	94	45.5	M10x55	FM UL
65/2½	76.1	300/2.07	142	98	45.5	M10x55	FM UL
80/3	88.9	300/2.07	164	112	46	M12x65	FM UL
100/4	108.0	300/2.07	187	134	50	M12x65	FM UL
100/4	114.3	300/2.07	190	138	50	M12x65	FM UL
125/5	133.0	300/2.07	212	160	50	M12x75	FM UL
125/5	139.7	300/2.07	223	168	50	M12x75	FM UL
125/5	141.3	300/2.07	226	170	50	M12x75	FM UL
150/6	159.0	300/2.07	244	188	50	M12x75	FM UL
150/6	165.1	300/2.07	247	194	50	M12x75	FM UL
150/6	168.3	300/2.07	250	196	50	M12x75	FM UL
200/8	219.1	300/2.07	320	254	60	M16x90	FM UL
250/10	273.0	300/2.07	408	316	65	M20x120	FM UL
300/12	323.9	300/2.07	460	372	65	M22x140	FM UL



**XGQT2**  
**Angle pad Coupling**

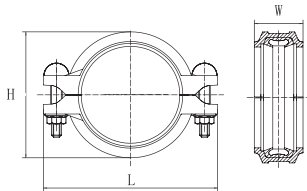

Nominal Size mm/in	Pipe O.D mm	Working Pressure PSI/Mpa	Dimensions mm			Bolt Size NO.-Size mm	Certificate
			L	H	W		
25/1	33.7	300/2.07	97	58	45.5	M10x55	FM UL
32/1¼	42.4	300/2.07	104	66	45.5	M10x55	FM UL
40/1½	48.3	300/2.07	114	72	45.5	M10x55	FM UL
50/2	60.3	300/2.07	128	85	45.5	M10x55	FM UL
65/2½	73.0	300/2.07	137	94	45.5	M10x55	FM UL
65/2½	76.1	300/2.07	142	98	45.5	M10x55	FM UL
80/3	88.9	300/2.07	164	112	46	M12x65	FM UL
100/4	108.0	300/2.07	187	134	50	M12x65	FM UL
100/4	114.3	300/2.07	190	138	50	M12x65	FM UL
125/5	133.0	300/2.07	212	160	50	M12x75	FM UL
125/5	139.7	300/2.07	223	168	50	M12x75	FM UL
125/5	141.3	300/2.07	226	170	50	M12x75	FM UL
150/6	159.0	300/2.07	244	188	50	M12x75	FM UL
150/6	165.1	300/2.07	247	194	50	M12x75	FM UL
150/6	168.3	300/2.07	250	196	50	M12x75	FM UL
200/8	219.1	300/2.07	320	254	60	M16x90	FM UL
250/10	273.0	300/2.07	408	316	65	M20x120	FM UL
300/12	323.9	300/2.07	460	372	65	M22x140	FM UL

**XGQT1B**  
**Flexible Reducing Coupling**

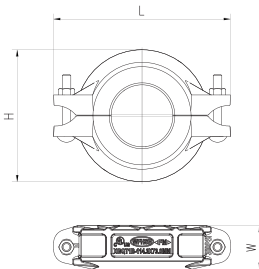

Nominal Size mm/in	Pipe O.D mm	Working Pressure PSI/Mpa	Dimensions mm			Bolt Size NO.-Size mm	Certificate
			L	H	W		
65X50/2½X2	73X60	300/2.07	143	102	45	M10X65	FM UL
65X50/3ODX2	76X60	300/2.07	143	102	45	M10X65	FM UL
80X50/3X2	89X60	300/2.07	163	118	47	M12X70	FM UL
80X65/3X2½	89X73	300/2.07	163	118	47	M12X70	FM UL
100X50/4X2	114X60	300/2.07	200	150	50	M12X70	FM UL
100X65/4X2½	114X73	300/2.07	200	150	50	M12X70	FM UL
100X65/4X3OD	114X76	300/2.07	200	150	50	M12X70	FM UL
100X80/4X3	114X89	300/2.07	200	150	50	M12X70	FM UL
150X100/6½ODX4	165X114	300/2.07	270	200	51	M16X85	FM UL
150X80/6X3	168X89	300/2.07	270	200	51	M16X85	FM UL
150X100/6X4	168X114	300/2.07	270	200	51	M16X85	FM UL
200X150/8X6½OD	219X165	300/2.07	335	260	63	M20X110	FM UL
200X150/8X6	219X168	300/2.07	335	260	63	M20X110	FM UL

## XGQT1 90°Elbow

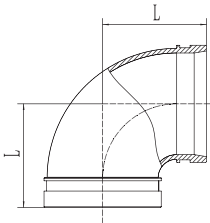

Nominal Size mm/in	Pipe O.D mm	Working Pressure PSI/Mpa	Dimensions L mm/in	Certificate
25/1	33.7	300/2.07	57/2.24	FM UL
32/1¼	42.4	300/2.07	60/2.36	FM UL
40/1½	48.3	300/2.07	60/2.36	FM UL
50/2	60.3	300/2.07	70/2.75	FM UL
65/2½	73.0	300/2.07	76/3.00	FM UL
65/2½	76.1	300/2.07	76/3.00	FM UL
80/3	88.9	300/2.07	86/3.39	FM UL
100/4	108.0	300/2.07	102/4.02	FM UL
100/4	114.3	300/2.07	102/4.02	FM UL
125/5	133.0	300/2.07	124/4.88	FM UL
125/5	139.7	300/2.07	124/4.88	FM UL
125/5	141.3	300/2.07	124/4.88	—
150/6	159.0	300/2.07	140/5.50	FM UL
150/6	165.1	300/2.07	140/5.50	FM UL
150/6	168.3	300/2.07	140/5.50	FM UL
200/8	219.1	300/2.07	173/6.81	FM UL
250/10	273.0	300/2.07	215/8.46	FM UL
300/12	323.9	300/2.07	245/9.65	FM UL

## XGQT02 45°Elbow

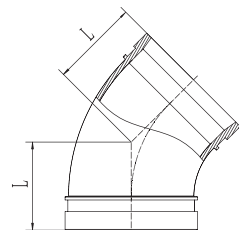

Nominal Size mm/in	Pipe O.D mm	Working Pressure PSI/Mpa	Dimensions L mm/in	Certificate
25/1	33.7	300/2.07	44/1.73	FM UL
32/1¼	42.4	300/2.07	44/1.73	FM UL
40/1½	48.3	300/2.07	44/1.73	FM UL
50/2	60.3	300/2.07	51/2.01	FM UL
65/2½	73.0	300/2.07	57/2.24	FM UL
65/2½	76.1	300/2.07	57/2.24	FM UL
80/3	88.9	300/2.07	64/2.52	FM UL
100/4	108.0	300/2.07	76/3.00	FM UL
100/4	114.3	300/2.07	76/3.00	FM UL
125/5	133.0	300/2.07	83/3.27	FM UL
125/5	139.7	300/2.07	83/3.27	FM UL
125/5	141.3	300/2.07	83/3.27	—
150/6	159.0	300/2.07	89/3.50	FM UL
150/6	165.1	300/2.07	89/3.50	FM UL
150/6	168.3	300/2.07	89/3.50	FM UL
200/8	219.1	300/2.07	108/4.25	FM UL
250/10	273.0	300/2.07	121/4.76	—
300/12	323.9	300/2.07	133/5.24	—



**XGQT09**  
**22.5°Elbow**

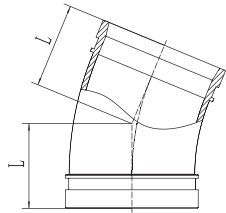

Nominal Size mm/in	Pipe OD mm/in	Working pressure psi/Mpa	Dimensions L mm/in
32 1¼	42.4 1.669	300 psi 2.07 Mpa	45 1.77
40 1½	48.3 1.9	300 psi 2.07 Mpa	45 1.77
50 2	60.3 2.375	300 psi 2.07 Mpa	48 1.88
65 2½	73 2.875	300 psi 2.07 Mpa	51 2.00
65 2½	76.1 3	300 psi 2.07 Mpa	51 2.00
80 3	88.9 3.5	300 psi 2.07 Mpa	57 2.24
100 4	108 4.25	300 psi 2.07 Mpa	73 2.87
100 4	114.3 4.5	300 psi 2.07 Mpa	73 2.87
125 5	133 5.25	300 psi 2.07 Mpa	73 2.87
125 5	139.7 5.5	300 psi 2.07 Mpa	73 2.87
150 6	159 6.25	300 psi 2.07 Mpa	89 3.50
150 6	165.1 6.5	300 psi 2.07 Mpa	89 3.50
150 6	168.3 6.625	300 psi 2.07 Mpa	89 3.50
200 8	219.1 8.625	300 psi 2.07 Mpa	98 3.85

**XGQT9**  
**11.25°Elbow**

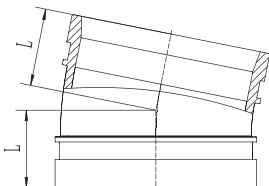

Nominal Size mm/in	Pipe OD mm/in	Working pressure psi/Mpa	Dimensions L mm/in
50 2	60.3 2.375	300 psi 2.07 Mpa	35 1.37
65 2½	76.1 3	300 psi 2.07 Mpa	38 1.49
80 3	88.9 3.5	300 psi 2.07 Mpa	38 1.49
100 4	108 4.25	300 psi 2.07 Mpa	44 1.73
100 4	114.3 4.5	300 psi 2.07 Mpa	44 1.73
125 5	133 5.25	300 psi 2.07 Mpa	51 2.00
125 5	139.7 5.5	300 psi 2.07 Mpa	51 2.00
150 6	159 6.25	300 psi 2.07 Mpa	51 2.00
150 6	165.1 6.5	300 psi 2.07 Mpa	51 2.00
150 6	168.3 6.625	300 psi 2.07 Mpa	51 2.00
200 8	219.1 8.625	300 psi 2.07 Mpa	51 2.00

## XGQT3 Grooved Mechanical Tee

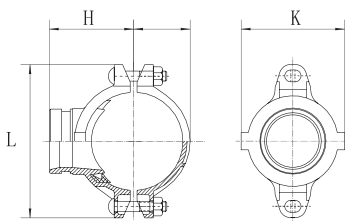

Nominal Size mm/in	Pipe O.D mm	Working Pressure PSI/Mpa	Hole Dia mm/in	Dimensions mm				Bolt Size NO.-Size mm	Certificate
				Φ	L	K	H		
50X32/2X1¼	60.3X42.4	300/2.07	51/2.00	75	116	68	75	M10x55	FM UL
50X40/2X1½	60.3X48.3	300/2.07	51/2.00	75	116	68	75	M10x55	FM UL
65X32/2½X1¼	73.0X42.4	300/2.07	51/2.00	92	128	76	83	M10x60	FM UL
65X40/2½X1½	73.0X48.3	300/2.07	51/2.00	92	128	76	83	M10x60	FM UL
65X32/3ODX1¼	76.1X42.4	300/2.07	51/2.00	96	128	76	83	M10x60	FM UL
65X40/3ODX1½	76.1X48.3	300/2.07	51/2.00	96	128	76	83	M10x60	FM UL
80X32/3X1¼	88.9X42.4	300/2.07	51/2.00	108	151	83	86	M12X65	FM UL
80X40/3X1½	88.9X48.3	300/2.07	51/2.00	108	151	83	86	M12X65	FM UL
80X50/3X2	88.9X60.3	300/2.07	64/2.50	108	151	83	101	M12X65	FM UL
100X65/4¼ODX3OD	108.0X76.1	300/2.07	70/2.75	130	180	100	110	M12X70	FM UL
100X80/4¼ODX3	108.0X88.9	300/2.07	89/3.50	130	180	100	124	M12X70	FM UL
100X25/4X1	114.3X33.7	300/2.07	38/1.50	136	183	100	76	M12X75	FM UL
100X32/4X1¼	114.3X42.4	300/2.07	51/2.00	136	183	100	86	M12X75	FM UL
100X40/4X1½	114.3X48.3	300/2.07	51/2.00	136	183	100	86	M12X75	FM UL
100X50/4X2	114.3X60.3	300/2.07	64/2.50	136	183	100	105	M12X75	FM UL
100X65/4X2½	114.3X73.0	300/2.07	70/2.75	136	183	100	110	M12X75	FM UL
100X65/4X3OD	114.3X76.1	300/2.07	70/2.75	136	183	100	110	M12X75	FM UL
100X80/4X3	114.3X88.9	300/2.07	89/3.50	136	183	100	124	M12X75	FM UL
125X32/5½ODX1¼	139.7X42.4	300/2.07	51/2.00	164	219	110	92	M16X80	FM UL
125X40/5½ODX1½	139.7X48.3	300/2.07	51/2.00	164	219	110	92	M16X80	FM UL
125X50/5½ODX2	139.7X60.3	300/2.07	64/2.50	164	219	110	105	M16X80	FM UL
125X65/5½ODX3OD	139.7X76.1	300/2.07	70/2.75	164	219	110	110	M16X80	FM UL
125X80/5½ODX3	139.7X88.9	300/2.07	89/3.50	164	219	110	124	M16X80	FM UL
125X32/5X1¼	141.3X42.4	300/2.07	51/2.00	164	219	110	92	M16X80	FM UL
125X40/5X1½	141.3X48.3	300/2.07	51/2.00	164	219	110	92	M16X80	FM UL
125X50/5X2	141.3X60.3	300/2.07	64/2.50	164	219	110	105	M16X80	FM UL
125X65/5X3OD	141.3X76.1	300/2.07	70/2.75	164	219	110	110	M16X80	FM UL
150X32/6½ODX1¼	165.1X42.4	300/2.07	51/2.00	190	245	123	90	M16X90	FM UL
150X40/6½ODX1½	165.1X48.3	300/2.07	51/2.00	190	245	123	90	M16X90	FM UL
150X50/6½ODX2	165.1X60.3	300/2.07	64/2.50	190	245	123	105	M16X90	FM UL
150X65/6½ODX3OD	165.1X76.1	300/2.07	70/2.75	190	245	123	110	M16X90	FM UL
150X80/6½ODX3	165.1X88.9	300/2.07	89/3.50	190	245	123	130	M16X90	FM UL
150X100/6½ODX4	165.1X114.3	300/2.07	114/4.50	190	245	125	159	M16X90	FM UL
150X32/6X1¼	168.3X42.4	300/2.07	51/2.00	192	250	127	90	M16X90	FM UL
150X40/6X1½	168.3X48.3	300/2.07	51/2.00	192	250	127	90	M16X90	FM UL
150X50/6X2	168.3X60.3	300/2.07	64/2.50	192	250	127	105	M16X90	FM UL
150X65/6X2½	168.3X73.0	300/2.07	70/2.75	192	250	127	110	M16X90	FM UL
150X65/6X3OD	168.3X76.1	300/2.07	70/2.75	192	250	127	110	M16X90	FM UL
150X80/6X3	168.3X88.9	300/2.07	89/3.50	192	250	127	130	M16X90	FM UL
150X100/6X4	168.3X114.3	300/2.07	114/4.50	192	250	127	159	M16X90	FM UL
200X50/8X2	219.1X60.3	300/2.07	64/2.50	240	302	150	105	M16X100	FM UL
200X65/8X3OD	219.1X76.1	300/2.07	70/2.75	240	302	150	115	M16X100	FM UL
200X80/8X3	219.1X88.9	300/2.07	89/3.50	240	302	150	134	M16X100	FM UL
200X100/8X4	219.1X114.3	300/2.07	114/4.50	240	302	150	167	M16X100	FM UL



**XGQT3S**  
**Threaded**  
**Mechanical**  
**Tee**

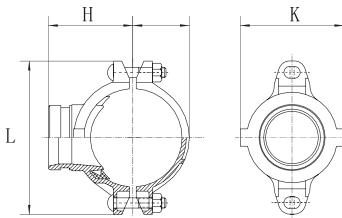

Nominal Size mm/in	Pipe O.D mm	Working Pressure PSI/Mpa	Hole Dia mm/in	Dimensions mm				Bolt Size NO.-Size mm	Certificate
				Φ	L	K	H		
50X25/2X1	60.3X33.7	300/2.07	38/1.50	75	116	58	72	M10x55	FM UL
50X32/2X1¼	60.3X42.4	300/2.07	51/2.00	75	116	63	75	M10x55	FM UL
50X40/2X1½	60.3X48.3	300/2.07	51/2.00	75	116	68	75	M10x55	—
65X32/2½X1	73.0X33.7	300/2.07	38/1.50	92	128	68	83	M10x60	FM UL
65X32/2½X1¼	73.0X42.4	300/2.07	51/2.00	92	128	76	72	M10x60	FM UL
65X40/2½X1½	73.0X48.3	300/2.07	51/2.00	92	128	76	83	M10x60	FM UL
65X32/2½X1	76.1X33.7	300/2.07	38/1.50	92	128	68	83	M10x60	FM UL
65X32/3ODX1¼	76.1X42.4	300/2.07	51/2.00	96	128	76	83	M10x60	FM UL
65X40/3ODX1½	76.1X48.3	300/2.07	51/2.00	96	128	76	83	M10x60	FM UL
80X25/3X1	88.9X33.7	300/2.07	38/1.50	108	151	78	74	M12X65	FM UL
80X32/3X1¼	88.9X42.4	300/2.07	51/2.00	108	151	78	86	M12X65	FM UL
80X40/3X1½	88.9X48.3	300/2.07	51/2.00	108	151	78	86	M12X65	FM UL
80X50/3X2	88.9X60.3	300/2.07	64/2.50	108	151	78	101	M12X65	FM UL
100X25/4¼ODX1	108.0X33.7	300/2.07	38/1.50	130	175	86	76	M12X70	FM UL
100X32/4¼ODX1¼	108.0X42.4	300/2.07	51/2.00	130	175	92	89	M12X70	FM UL
100X40/4¼ODX1½	108.0X48.3	300/2.07	51/2.00	130	175	92	89	M12X70	FM UL
100X50/4¼ODX2	108.0X60.3	300/2.07	64/2.50	130	175	96	105	M12X70	FM UL
100X65/4¼ODX2½	108.0X73.0	300/2.07	70/2.75	130	175	98	110	M12X70	FM UL
100X65/4¼ODX3OD	108.0X76.1	300/2.07	70/2.75	130	175	98	110	M12X70	FM UL
100X80/4¼ODX3	108.0X88.9	300/2.07	89/3.50	130	175	98	124	M12X70	FM UL
100X25/4X1	114.3X33.7	300/2.07	38/1.50	136	183	88	76	M12X75	FM UL
100X32/4X1¼	114.3X42.4	300/2.07	51/2.00	136	183	94	89	M12X75	FM UL
100X40/4X1½	114.3X48.3	300/2.07	51/2.00	136	183	94	89	M12X75	FM UL
100X50/4X2	114.3X60.3	300/2.07	64/2.50	136	183	98	105	M12X75	FM UL
100X65/4X2½	114.3X73.0	300/2.07	70/2.75	136	183	100	110	M12X75	FM UL
100X65/4X3OD	114.3X76.1	300/2.07	70/2.75	136	183	100	110	M12X75	FM UL
100X80/4X3	114.3X88.9	300/2.07	89/3.50	136	183	100	124	M12X75	FM UL
125X32/5¼ODX1	133.0X33.7	300/2.07	38/1.50	157	212	100	80	M12X75	FM UL
125X32/5¼ODX1¼	133.0X42.4	300/2.07	51/2.00	158	212	100	93	M12X75	FM UL
125X40/5¼ODX1½	133.0X48.3	300/2.07	51/2.00	159	212	100	93	M12X75	FM UL
125X50/5¼ODX2	133.0X60.3	300/2.07	64/2.50	160	212	104	105	M12X75	FM UL
125X65/5¼ODX3OD	133.0X76.1	300/2.07	70/2.75	161	212	104	112	M12X75	FM UL
125X80/5¼ODX3	133.0X88.9	300/2.07	89/3.50	162	212	107	131	M12X75	FM UL
125X32/5½ODX1	139.7X33.7	300/2.07	38/1.50	164	219	103	80	M16X80	FM UL
125X32/5½ODX1¼	139.7X42.4	300/2.07	51/2.00	164	219	103	93	M16X80	FM UL
125X40/5½ODX1½	139.7X48.3	300/2.07	51/2.00	164	219	103	93	M16X80	FM UL
125X50/5½ODX2	139.7X60.3	300/2.07	64/2.50	164	219	107	105	M16X80	FM UL
125X65/5½ODX3OD	139.7X76.1	300/2.07	70/2.75	164	219	107	112	M16X80	FM UL
125X80/5½ODX3	139.7X88.9	300/2.07	89/3.50	164	219	110	131	M16X80	FM UL
125X32/5X1	141.3X33.7	300/2.07	38/1.50	164	219	103	80	M16X80	FM UL

## XGQT3S Threaded Mechanical Tee

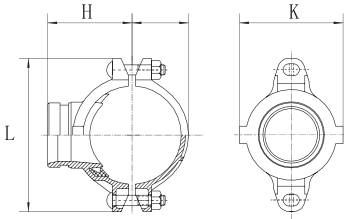

Nominal Size mm/in	Pipe O.D mm	Working Pressure PSI/Mpa	Hole Dia mm/in	Dimensions mm				Bolt Size NO.-Size mm	Certificate
				Φ	L	K	H		
125X32/5X1¼	141.3X42.4	300/2.07	51/2.00	164	219	103	93	M16X80	FM UL
125X40/5X1½	141.3X48.3	300/2.07	51/2.00	164	219	103	93	M16X80	FM UL
125X50/5X2	141.3X60.3	300/2.07	64/2.50	164	219	107	105	M16X80	FM UL
125X65/5X3OD	141.3X76.1	300/2.07	70/2.75	164	219	107	112	M16X80	FM UL
125X80/5X3	141.3X88.9	300/2.07	89/3.50	164	219	110	131	M16X80	FM UL
150X25/6¼ODX1	159.0X33.7	300/2.07	38/1.50	190	245	116	80	M16X90	FM UL
150X32/6¼ODX1¼	159.0X42.4	300/2.07	51/2.00	190	245	120	90	M16X90	FM UL
150X40/6¼ODX1½	159.0X48.3	300/2.07	51/2.00	190	245	120	90	M16X90	FM UL
150X50/6¼ODX2	159.0X60.3	300/2.07	64/2.50	190	245	123	105	M16X90	FM UL
150X65/6¼ODX3OD	159.0X76.1	300/2.07	70/2.75	190	245	123	110	M16X90	FM UL
150X80/6¼ODX3	159.0X88.9	300/2.07	89/3.50	190	245	123	130	M16X90	FM UL
150X25/6½ODX1	165.1X33.7	300/2.07	38/1.50	190	245	116	80	M16X90	FM UL
150X32/6½ODX1¼	165.1X42.4	300/2.07	51/2.00	190	245	120	90	M16X90	FM UL
150X40/6½ODX1½	165.1X48.3	300/2.07	51/2.00	190	245	120	90	M16X90	FM UL
150X50/6½ODX2	165.1X60.3	300/2.07	64/2.50	190	245	123	105	M16X90	FM UL
150X65/6½ODX3OD	165.1X76.1	300/2.07	70/2.75	190	245	123	110	M16X90	FM UL
150X80/6½ODX3	165.1X88.9	300/2.07	89/3.50	190	245	123	130	M16X90	FM UL
150X32/6X1	168.3X33.7	300/2.07	38/1.50	192	250	117	80	M16X90	FM UL
150X32/6X1¼	168.3X42.4	300/2.07	51/2.00	192	250	121	90	M16X90	FM UL
150X40/6X1½	168.3X48.3	300/2.07	51/2.00	192	250	121	90	M16X90	FM UL
150X50/6X2	168.3X60.3	300/2.07	64/2.50	192	250	124	105	M16X90	FM UL
150X65/6X2½	168.3X73.0	300/2.07	70/2.75	192	250	124	110	M16X90	FM UL
150X65/6X3OD	168.3X76.1	300/2.07	70/2.75	192	250	124	110	M16X90	FM UL
150X80/6X3	168.3X88.9	300/2.07	89/3.50	192	250	124	130	M16X90	FM UL
200X50/8X1	219.1X33.7	300/2.07	38/1.50	240	302	140	80	M16X100	FM UL
200X50/8X1¼	219.1X42.4	300/2.07	51/2.00	240	302	142	92	M16X100	FM UL
200X50/8X1½	219.1X48.3	300/2.07	51/2.00	240	302	142	92	M16X100	FM UL
200X50/8X2	219.1X60.3	300/2.07	64/2.50	240	302	150	105	M16X100	FM UL
200X65/8X3OD	219.1X76.1	300/2.07	70/2.75	240	302	150	115	M16X100	FM UL
200X80/8X3	219.1X88.9	300/2.07	89/3.50	240	302	150	134	M16X100	FM UL
200X100/8X4	219.1X114.3	300/2.07	114/4.50	246	302	158	167	M16X100	FM UL



**XGQT3U**  
**U-bolted**  
**Threaded**  
**Mechanical**  
**Tee**

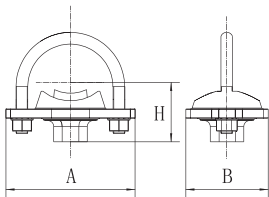

"Nominal Size mm/in"	Pipe O.D mm	Working Pressure PSI/Mpa	Hole Dia mm/in	Dimensions mm			U-Bolt Size NO.-Size mm	Certificate
				A	B	H		
25X15/1X1/2	33.7X21.3	300/2.07	24/0.94	89	58	45	M10X65	FM UL
32X15/1 1/4X1/2	42.4X21.3	300/2.07	30/1.18	89	58	49	M10X75	FM UL
32X20/1 1/4X3/4	42.4X26.9	300/2.07	30/1.18	89	58	49	M10X75	FM UL
32X25/1 1/4X1	42.4X33.7	300/2.07	30/1.18	89	58	49	M10X75	FM UL
40X15/1 1/2X1/2	48.3X21.3	300/2.07	30/1.18	89	58	52	M10X75	FM UL
40X20/1 1/2X3/4	48.3X26.9	300/2.07	30/1.18	89	58	52	M10X75	FM UL
40X25/1 1/2X1	48.3X33.7	300/2.07	30/1.18	89	58	52	M10X75	FM UL
50X15/2X1/2	60.3X21.3	300/2.07	30/1.18	89	58	58	M10X92	FM UL
50X20/2X3/4	60.3X26.9	300/2.07	30/1.18	89	58	58	M10X92	FM UL
50X25/2X1	60.3X33.7	300/2.07	30/1.18	89	58	58	M10X92	FM UL
50X32/2X1 1/4	60.3X42.4	300/2.07	45/1.75	89	58	58	M10X92	FM UL
65X15/2 1/2X1/2	73.0X21.3	300/2.07	30/1.18	109	58	68	M10X105	FM UL
65X20/2 1/2X1 3/4	73.0X26.9	300/2.07	30/1.18	109	58	68	M10X105	FM UL
65X15/3ODX1/2	76.1X21.3	300/2.07	30/1.18	109	58	68	M10X105	FM UL
65X20/3ODX3/4	76.1X26.9	300/2.07	30/1.18	109	58	68	M10X105	FM UL
65X25/3ODX1	76.1X33.7	300/2.07	30/1.18	109	58	68	M10X105	FM UL
80X25/3X1	88.9X33.7	300/2.07	38/1.50	146	74	80	M12X110	FM UL

**XGQT08**  
**Grooved**  
**Split**  
**Flange**

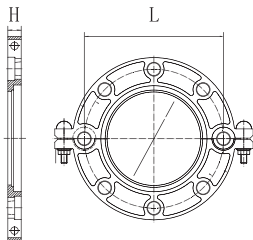

Nominal Size mm/in	Pipe O.D mm	Working Pressure PSI/Mpa	Dimensions mm/in			Certificate
			L	H	n-Φ	
50/2	60.3	300/2.07	125/4.92	18.5/0.73	4-M16	FM UL
65/2 1/2	73.0	300/2.07	140/5.51	19/0.75	4-M16	FM UL
65/2 1/2	76.1	300/2.07	145/5.71	18.5/0.73	4-M16	FM UL
80/3	88.9	300/2.07	160/6.30	18.5/0.73	8-M16	FM UL
100/4	108.0	300/2.07	180/7.09	18.5/0.73	8-M16	FM UL
100/4	114.3	300/2.07	180/7.09	18.5/0.73	8-M16	FM UL
125/5	133.0	300/2.07	210/8.27	21.5/0.85	8-M16	FM UL
125/5	139.7	300/2.07	210/8.27	21.5/0.85	8-M16	FM UL
125/5	141.3	300/2.07	216/8.50	22/0.87	8-M16	FM UL
150/6	159.0	300/2.07	240/9.45	21.5/0.85	8-M20	FM UL
150/6	165.1	300/2.07	240/9.45	21.5/0.85	8-M20	FM UL
150/6	168.3	300/2.07	240/9.45	24/0.94	8-M20	FM UL
200/8	219.1	300/2.07	295/11.61	30/1.18	12-M20	FM UL
250/10	273.0	300/2.07	355/13.98	25.4/1	12-M24	FM UL
300/12	323.9	300/2.07	410/16.14	25.4/1	12-M24	FM UL

## XGQT03 Equal Tee

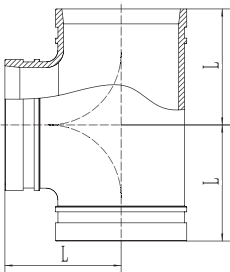

Nominal Size mm/in	Pipe O.D mm	Working Pressure PSI/Mpa	Dimensions mm/in	L	Certificate
25/1	33.7	300/2.07	57/2.24		FM UL
32/1¼	42.4	300/2.07	60/2.36		FM UL
40/1½	48.3	300/2.07	60/2.36		FM UL
50/2	60.3	300/2.07	70/2.75		FM UL
65/2½	73.0	300/2.07	76/3.00		FM UL
65/2½	76.1	300/2.07	76/3.00		FM UL
80/3	88.9	300/2.07	86/3.39		FM UL
100/4	108.0	300/2.07	102/4.02		FM UL
100/4	114.3	300/2.07	102/4.02		FM UL
125/5	133.0	300/2.07	124/4.88		FM UL
125/5	139.7	300/2.07	124/4.88		FM UL
125/5	141.3	300/2.07	124/4.88		—
150/6	159.0	300/2.07	140/5.50		FM UL
150/6	165.1	300/2.07	140/5.50		FM UL
150/6	168.3	300/2.07	140/5.50		FM UL
200/8	219.1	300/2.07	173/6.81		FM UL
250/10	273.0	300/2.07	215/8.46		FM UL
300/12	323.9	300/2.07	245/9.65		FM UL

## XGQT04 Grooved Reducing Tee

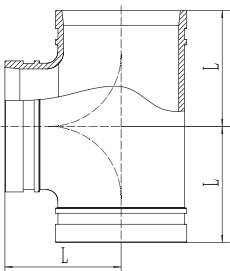

Nominal Size mm/in	Pipe O.D mm	Working Pressure PSI/Mpa	Dimensions mm/in		Certificate
			Φ	L	
50X25/2X1	60.3X33.7	300/2.07	70/2.57	70/2.57	FM UL
50X32/2X1¼	60.3X42.4	300/2.07	70/2.57	70/2.57	FM UL
50X40/2X1½	60.3X48.3	300/2.07	70/2.57	70/2.57	FM UL
65X32/2½X1¼	73.0X42.4	300/2.07	76/3.00	76/3.00	FM UL
65X40/2½X1½	73.0X48.3	300/2.07	76/3.00	76/3.00	FM UL
65X50/2½X2	73.0X60.3	300/2.07	76/3.00	76/3.00	FM UL
65X40/3ODX1½	76.1X48.3	300/2.07	76/3.00	76/3.00	FM UL
65X50/3ODX2	76.1X60.3	300/2.07	76/3.00	76/3.00	FM UL
80X40/3X1½	88.9X48.3	300/2.07	86/3.38	86/3.38	FM UL
80X50/3X2	88.9X60.3	300/2.07	86/3.38	86/3.38	FM UL
80X65/3X2½	88.9X73.0	300/2.07	86/3.38	86/3.38	FM UL
80X65/3X3OD	88.9X76.1	300/2.07	86/3.38	86/3.38	FM UL
100X65/4¼ODX3OD	108.0X76.1	300/2.07	102/4.01	102/4.01	FM UL
100X80/4¼ODX3	108.0X88.9	300/2.07	102/4.01	102/4.01	FM UL
100X50/4X2	114.3X60.3	300/2.07	102/4.01	102/4.01	FM UL
100X65/4X2½	114.3X73.0	300/2.07	102/4.01	102/4.01	FM UL
100X65/4X3OD	114.3X76.1	300/2.07	102/4.01	102/4.01	FM UL
100X80/4X3	114.3X88.9	300/2.07	102/4.01	102/4.01	FM UL
125X50/5½ODX2	139.7X60.3	300/2.07	124/4.88	124/4.88	FM UL

**XGQT04**  
**Grooved**  
**Reducing**  
**Tee**

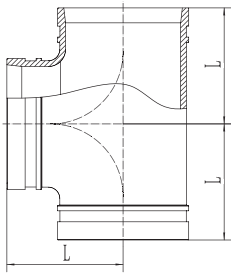

Nominal Size mm/in	Pipe O.D mm	Working Pressure PSI/Mpa	Dimensions mm/in		Certificate
			Φ	L	
125X80/5½ODX3	139.7X88.9	300/2.07	124/4.88	124/4.88	FM UL
125X100/5½ODX4	139.7X114.3	300/2.07	124/4.88	124/4.88	FM UL
150X65/6¼ODX3OD	159.0X76.1	300/2.07	140/5.50	140/5.50	FM UL
150X80/6¼ODX3	159.0X88.9	300/2.07	140/5.50	140/5.50	FM UL
150X100/6¼ODX4¼OD	159.0X108.0	300/2.07	140/5.50	140/5.50	FM UL
150X100/6¼ODX4	159.0X114.3	300/2.07	140/5.50	140/5.50	FM UL
150X50/6½ODX2	165.1X60.3	300/2.07	140/5.50	140/5.50	FM UL
150X65/6½ODX3OD	165.1X76.1	300/2.07	140/5.50	140/5.50	FM UL
150X80/6½ODX3OD	165.1X88.9	300/2.07	140/5.50	140/5.50	FM UL
150X100/6½ODX4	165.1X114.3	300/2.07	140/5.50	140/5.50	FM UL
150X125/6½ODX5½OD	165.1X139.7	300/2.07	140/5.50	140/5.50	FM UL
150X50/6X2	168.3X60.3	300/2.07	140/5.50	140/5.50	FM UL
150X65/6X2½	168.3X73.0	300/2.07	140/5.50	140/5.50	FM UL
150X65/6X3OD	168.3X76.1	300/2.07	140/5.50	140/5.50	FM UL
150X80/6X3	168.3X88.9	300/2.07	140/5.50	140/5.50	FM UL
150X100/6X4	168.3X114.3	300/2.07	140/5.50	140/5.50	FM UL
200X100/8X4	219.1X114.3	300/2.07	175/6.89	175/6.89	FM UL
200X125/8X5½OD	219.1X139.7	300/2.07	175/6.89	175/6.89	FM UL
200X150/8X6¼OD	219.1X159.0	300/2.07	175/6.89	175/6.89	FM UL
200X150/8X6½OD	219.1X165.1	300/2.07	175/6.89	175/6.89	FM UL
200X150/8X6	219.1X168.3	300/2.07	175/6.89	175/6.89	FM UL

**XGQT06**  
**End Cap**

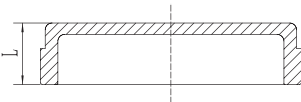

Nominal Size mm/in	Pipe O.D mm	Working Pressure PSI/Mpa	Dimensions L mm/in	Certificate
25/1	33.7	300/2.07	22/0.87	FM UL
32/1¼	42.4	300/2.07	24/0.94	FM UL
40/1½	48.3	300/2.07	24/0.94	FM UL
50/2	60.3	300/2.07	24/0.94	FM UL
65/2½	76.1	300/2.07	24/0.94	FM UL
80/3	88.9	300/2.07	24/0.94	FM UL
100/4	114.3	300/2.07	26/1.02	FM UL
125/5	139.7	300/2.07	26/1.02	FM UL
150/6	165.1	300/2.07	26/1.02	FM UL
150/6	168.3	300/2.07	26/1.02	FM UL
200/8	219.1	300/2.07	28/1.10	FM UL



## XGQT04S Threaded Reducing Tee

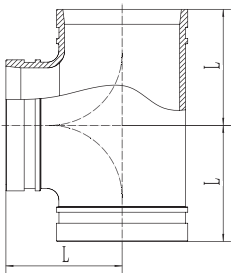

Nominal Size mm/in	Pipe O.D mm	Working Pressure PSI/Mpa	Dimensions mm/in		Certificate
			Φ	L	
50X25/2X1	60.3X33.7	300/2.07	70/2.57	70/2.57	FM UL
50X32/2X1¼	60.3X42.4	300/2.07	70/2.57	70/2.57	FM UL
50X40/2X1½	60.3X48.3	300/2.07	70/2.57	70/2.57	FM UL
65X32/2½X1¼	73.0X42.4	300/2.07	76/3.00	76/3.00	FM UL
65X40/2½X1½	73.0X48.3	300/2.07	76/3.00	76/3.00	FM UL
65X50/2½X2	73.0X60.3	300/2.07	76/3.00	76/3.00	FM UL
65X25/3ODX1	76.1X33.7	300/2.07	76/3.00	76/3.00	FM UL
65X40/3ODX1½	76.1X48.3	300/2.07	76/3.00	76/3.00	FM UL
65X50/3ODX2	76.1X60.3	300/2.07	76/3.00	76/3.00	FM UL
80X25/3X1	88.9X33.7	300/2.07	86/3.38	86/3.38	FM UL
80X32/3X1¼	88.9X42.4	300/2.07	86/3.38	86/3.38	FM UL
80X40/3X1½	88.9X48.3	300/2.07	86/3.38	86/3.38	FM UL
80X50/3X2	88.9X60.3	300/2.07	86/3.38	86/3.38	FM UL
80X65/3X3OD	88.9X76.1	300/2.07	86/3.38	86/3.38	FM UL
100X65/4¼ODX3OD	108.0X76.1	300/2.07	102/4.01	102/4.01	FM UL
100X80/4¼ODX3	108.0X88.9	300/2.07	102/4.01	102/4.01	FM UL
100X25/4X1	114.3X33.7	300/2.07	102/4.01	102/4.01	FM UL
100X32/4X1¼	114.3X42.4	300/2.07	102/4.01	102/4.01	FM UL
100X40/4X1½	114.3X48.3	300/2.07	102/4.01	102/4.01	FM UL
100X50/4X2	114.3X60.3	300/2.07	102/4.01	102/4.01	FM UL
100X65/4X2½	114.3X73.0	300/2.07	102/4.01	102/4.01	FM UL
100X65/4X3OD	114.3X76.1	300/2.07	102/4.01	102/4.01	FM UL
100X80/4X3	114.3X88.9	300/2.07	102/4.01	102/4.01	FM UL
125X25/5½ODX1	139.7X33.7	300/2.07	124/4.88	124/4.88	FM UL
125X32/5½ODX1¼	139.7X42.4	300/2.07	124/4.88	124/4.88	FM UL
125X40/5½ODX1½	139.7X48.3	300/2.07	124/4.88	124/4.88	FM UL
125X50/5½ODX2	139.7X60.3	300/2.07	124/4.88	124/4.88	FM UL
125X65/5½ODX2½	139.7X76.1	300/2.07	124/4.88	124/4.88	FM UL
125X80/5½ODX3	139.7X88.9	300/2.07	124/4.88	124/4.88	FM UL
150X65/6¼ODX3OD	159.0X76.1	300/2.07	140/5.50	140/5.50	FM UL
150X80/6¼ODX3	159.0X88.9	300/2.07	140/5.50	140/5.50	FM UL
150X25/6½ODX1	165.1X33.7	300/2.07	140/5.50	140/5.50	FM UL
150X32/6½ODX1¼	165.1X42.4	300/2.07	140/5.50	140/5.50	FM UL
150X40/6½ODX1½	165.1X48.3	300/2.07	140/5.50	140/5.50	FM UL
150X50/6½ODX2	165.1X60.3	300/2.07	140/5.50	140/5.50	FM UL
150X65/6½ODX3OD	165.1X76.1	300/2.07	140/5.50	140/5.50	FM UL
150X80/6½ODX3OD	165.1X88.9	300/2.07	140/5.50	140/5.50	FM UL
150X25/6X1	168.3X33.7	300/2.07	140/5.50	140/5.50	FM UL
150X32/6X1¼	168.3X42.4	300/2.07	140/5.50	140/5.50	FM UL
150X50/6X2	168.3X60.3	300/2.07	140/5.50	140/5.50	FM UL
150X65/6X2½	168.3X73.0	300/2.07	140/5.50	140/5.50	FM UL
150X80/6X3	168.3X88.9	300/2.07	140/5.50	140/5.50	FM UL
200X65/8X3OD	219.1X76.1	300/2.07	175/6.89	175/6.89	FM UL
200X80/8X3	219.1X88.9	300/2.07	175/6.89	175/6.89	FM UL

**XGQT07**  
**Equal Cross**

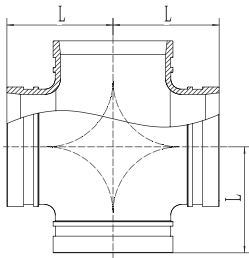

Nominal Size mm/in	Pipe O.D mm	Working Pressure PSI/Mpa	Dimensions L mm/in	Certificate
25/1	33.7	300/2.07	57/2.24	—
32/1¼	42.4	300/2.07	60/2.36	—
40/1½	48.3	300/2.07	60/2.36	—
50/2	60.3	300/2.07	70/2.75	FM UL
65/2½	73.0	300/2.07	76/3.00	FM UL
65/2½	76.1	300/2.07	76/3.00	FM UL
80/3	88.9	300/2.07	86/3.39	FM UL
100/4	108.0	300/2.07	102/4.02	—
100/4	114.3	300/2.07	102/4.02	FM UL
125/5	133.0	300/2.07	124/4.88	—
125/5	139.7	300/2.07	124/4.88	FM UL
125/5	141.3	300/2.07	124/4.88	—
150/6	159.0	300/2.07	140/5.50	FM UL
150/6	165.1	300/2.07	140/5.50	FM UL
150/6	168.3	300/2.07	140/5.50	FM UL
200/8	219.1	300/2.07	173/6.81	FM UL
250/10	273.0	300/2.07	215/8.46	—
300/12	323.9	300/2.07	245/9.65	—

**XGQT7S**  
**Threaded  
Reducing  
Cross**

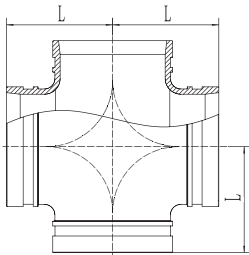

Nominal Size mm/in	Pipe O.D mm	Working Pressure PSI/Mpa	Dimensions mm/in		Certificate
			L1	L2	
100X25/4X1	114.3X33.7	300/2.07	102/4.01	102/4.01	FM UL
100X32/4X1¼	114.3X42.4	300/2.07	102/4.01	102/4.01	FM UL
100X40/4X1½	114.3X48.3	300/2.07	102/4.01	102/4.01	FM UL
100X50/4X2	114.3X60.3	300/2.07	102/4.01	102/4.01	FM UL
100X65/4X3OD	114.3X76.1	300/2.07	102/4.01	102/4.01	FM UL
100X80/4X3	114.3X88.9	300/2.07	102/4.01	102/4.01	FM UL
125X32/5½ODX1¼	139.7X42.4	300/2.07	124/4.88	124/4.88	FM UL
125X40/5½ODX1½	139.7X48.3	300/2.07	124/4.88	124/4.88	FM UL
125X50/5½ODX2	139.7X60.3	300/2.07	124/4.88	124/4.88	FM UL
125X65/5½ODX2½	139.7X76.1	300/2.07	124/4.88	124/4.88	FM UL
125X80/5½ODX3	139.7X88.9	300/2.07	124/4.88	124/4.88	FM UL
150X25/6½ODX1	165.1X33.7	300/2.07	140/5.50	140/5.50	FM UL
150X32/6½ODX1¼	165.1X42.4	300/2.07	140/5.50	140/5.50	FM UL
150X40/6½ODX1½	165.1X48.3	300/2.07	140/5.50	140/5.50	FM UL
150X50/6½ODX2	165.1X60.3	300/2.07	140/5.50	140/5.50	FM UL
150X65/6½ODX3OD	165.1X76.1	300/2.07	140/5.50	140/5.50	FM UL
150X80/6½ODX3OD	165.1X88.9	300/2.07	140/5.50	140/5.50	FM UL

## XGQT7

### Grooved Reducing Cross

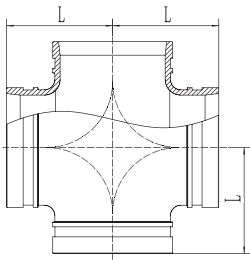

Nominal Size mm/in	Pipe O.D mm	Working Pressure PSI/Mpa	Dimensions mm/in	
			L1	L2
100X25/4X1	114.3X33.7	300/2.07	102/4.01	102/4.01
100X32/4X1¼	114.3X42.4	300/2.07	102/4.01	102/4.01
100X40/4X1½	114.3X48.3	300/2.07	102/4.01	102/4.01
100X50/4X2	114.3X60.3	300/2.07	102/4.01	102/4.01
100X65/4X3OD	114.3X76.1	300/2.07	102/4.01	102/4.01
100X80/4X3	114.3X88.9	300/2.07	102/4.01	102/4.01
125X32/5½ODX1¼	139.7X42.4	300/2.07	124/4.88	124/4.88
125X40/5½ODX1½	139.7X48.3	300/2.07	124/4.88	124/4.88
125X50/5½ODX2	139.7X60.3	300/2.07	124/4.88	124/4.88
125X65/5½ODX2½	139.7X76.1	300/2.07	124/4.88	124/4.88
125X80/5½ODX3	139.7X88.9	300/2.07	124/4.88	124/4.88
150X25/6½ODX1	165.1X33.7	300/2.07	140/5.50	140/5.50
150X32/6½ODX1¼	165.1X42.4	300/2.07	140/5.50	140/5.50
150X40/6½ODX1½	165.1X48.3	300/2.07	140/5.50	140/5.50
150X50/6½ODX2	165.1X60.3	300/2.07	140/5.50	140/5.50
150X65/6½ODX3OD	165.1X76.1	300/2.07	140/5.50	140/5.50
150X80/6½ODX3OD	165.1X88.9	300/2.07	140/5.50	140/5.50

## XGQT8

### Adaptor Flange

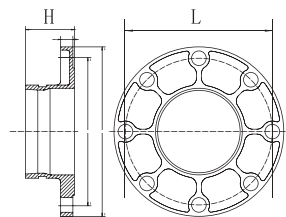

Nominal Size mm/in	Pipe O.D mm	Working Pressure PSI/Mpa	Dimensions mm/in			Certificate
			L	H	n-φ	
50/2	60.3	300/2.07	125/4.92	65/2.56	4-M16	FM UL
65/2½	73.0	300/2.07	145/5.71	65/2.56	4-M16	FM UL
65/2½	76.1	300/2.07	145/5.71	65/2.56	4-M16	FM UL
80/3	88.9	300/2.07	160/6.30	65/2.56	8-M16	FM UL
100/4	108.0	300/2.07	180/7.09	70/2.76	8-M16	FM UL
100/4	114.3	300/2.07	180/7.09	70/2.76	8-M16	FM UL
125/5	133.0	300/2.07	210/8.27	70/2.76	8-M16	FM UL
125/5	139.7	300/2.07	210/8.27	70/2.76	8-M16	FM UL
150/6	159.0	300/2.07	240/9.45	70/2.76	8-M20	FM UL
150/6	165.1	300/2.07	240/9.45	70/2.76	8-M20	FM UL
150/6	168.3	300/2.07	240/9.45	70/2.76	8-M20	FM UL
200/8	219.1	300/2.07	295/11.61	80/3.15	12-M20	FM UL



**XGQT5**  
**Grooved**  
**Concentric**  
**Reducer**

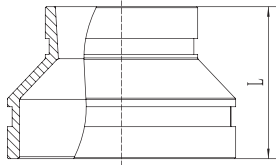

Nominal Size mm/in	Pipe O.D mm	Working Pressure PSI/Mpa	Dimensions L mm	Certificate
50X25/2X1	60.3X33.7	300/2.07	64	FM UL
50X32/2X1¼	60.3X42.4	300/2.07	64	FM UL
50X40/2X1½	60.3X48.3	300/2.07	64	FM UL
65X25/2½X1	73.0X33.7	300/2.07	64	FM UL
65X32/2½X1¼	73.0X42.4	300/2.07	64	FM UL
65X40/2½X1½	73.0X48.3	300/2.07	64	FM UL
65X25/3ODX1	76.1X33.7	300/2.07	64	FM UL
65X32/3ODX1¼	76.1X42.4	300/2.07	64	FM UL
65X40/3ODX1½	76.1X48.3	300/2.07	64	FM UL
65X50/3ODX2	76.1X60.3	300/2.07	64	FM UL
80X25/3X1	88.9X33.7	300/2.07	64	FM UL
80X32/3X1¼	88.9X42.4	300/2.07	64	FM UL
80X40/3X1½	88.9X48.3	300/2.07	64	FM UL
80X50/3X2	88.9X60.3	300/2.07	64	FM UL
80X65/3X2½	88.9X73.0	300/2.07	64	FM UL
80X65/3X3OD	88.9X76.1	300/2.07	64	FM UL
100X65/4¼ODX3OD	108.0X76.1	300/2.07	76	FM UL
100X80/4¼ODX3	108.0X88.9	300/2.07	76	FM UL
100X50/4X2	114.3X60.3	300/2.07	76	FM UL
100X65/4X2½	114.3X73.0	300/2.07	76	FM UL
100X65/4X3OD	114.3X76.1	300/2.07	76	FM UL
100X80/4X3	114.3X88.9	300/2.07	76	FM UL
125X100/5½ODX4¼OD	133.0X108.0	300/2.07	89	FM UL
125X100/5½ODX4	133.0X114.3	300/2.07	89	FM UL
125X50/5½ODX2	139.7X60.3	300/2.07	89	FM UL
125X65/5½ODX3OD	139.7X76.1	300/2.07	89	FM UL
125X80/5½ODX3	139.7X88.9	300/2.07	89	FM UL
125X100/5½ODX4	139.7X114.3	300/2.07	89	FM UL
150X50/6¼ODX2	159.0X60.3	300/2.07	89	FM UL
150X65/6¼ODX3OD	159.0X76.1	300/2.07	89	FM UL
150X80/6¼ODX3	159.0X88.9	300/2.07	89	FM UL
150X100/6¼ODX4¼OD	159.0X108.0	300/2.07	89	FM UL
150X100/6¼ODX4	159.0X114.3	300/2.07	89	FM UL
150X125/6¼ODX5½OD	159.0X133.0	300/2.07	89	FM UL
150X50/6½ODX2	165.1X60.3	300/2.07	102	FM UL
150X65/6½ODX3OD	165.1X76.1	300/2.07	102	FM UL
150X80/6½ODX3	165.1X88.9	300/2.07	102	FM UL
150X100/6½ODX4	165.1X114.3	300/2.07	102	FM UL
150X125/6½ODX5½OD	165.1X139.7	300/2.07	102	FM UL
150X50/6X2	168.3X60.3	300/2.07	102	FM UL
150X65/6X2½	168.3X73.0	300/2.07	102	FM UL

## XGQT5 Grooved Concentric Reducer

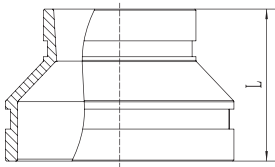

Nominal Size mm/in	Pipe O.D mm	Working Pressure PSI/Mpa	Dimensions L mm	Certificate
150X65/6X3OD	168.3X76.1	300/2.07	102	FM UL
150X80/6X3	168.3X88.9	300/2.07	102	FM UL
150X100/6X4	168.3X114.3	300/2.07	102	FM UL
150X125/6X5½OD	168.3X139.7	300/2.07	102	FM UL
200X50/8X2	219.1X60.3	300/2.07	127	FM UL
200X65/8X3OD	219.1X76.1	300/2.07	127	FM UL
200X80/8X3	219.1X88.9	300/2.07	127	FM UL
200X100/8X4	219.1X114.3	300/2.07	127	FM UL
200X125/8X5½OD	219.1X139.7	300/2.07	127	FM UL
200X150/8X6½OD	219.1X165.1	300/2.07	127	FM UL
200X100/8X4	219.1X168.3	300/2.07	127	FM UL

## XGQT05 Grooved Eccentric Reducer

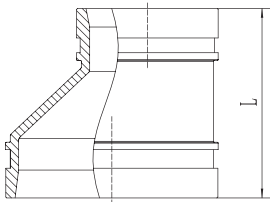

Nominal Size mm/in	Pipe O.D mm	Working Pressure PSI/Mpa	Dimensions L mm
80X50 3X2	88.9X60.3 3.500X2.375	300/2.07	89 3.50
100X65 4X2½	108.0X76.1 4.250X3.000	300/2.07	102 4.01
100X80 4X3	108.0X88.9 4.250X3.500	300/2.07	102 4.01
100X50 4X2	114.3X60.3 4.500X2.375	300/2.07	102 4.01
100X65 4X2½	114.3X76.1 4.500X3.000	300/2.07	102 4.01
100X80 4X3	114.3X88.9 4.500X3.500	300/2.07	102 4.01
125X80 5X3	139.7X88.9 5.500X3.500	300/2.07	102 4.01
125X100 5X4	139.7X114.3 5.500X4.500	300/2.07	102 4.01
150X80 6X3	159.0X88.9 6.250X3.500	300/2.07	102 4.01
150X100 6X4	159.0X108.0 6.250X4.250	300/2.07	102 4.01
150X100 6X4	159.0X114.3 6.250X4.500	300/2.07	102 4.01
150X65 6X2½	165.1X76.1 6.500X3.000	300/2.07	102 4.01
150X80 6X3	165.1X88.9 6.500X3.500	300/2.07	102 4.01
150X100 6X4	165.1X114.3 6.500X4.500	300/2.07	102 4.01
150X125 6X5	165.1X139.7 6.500X5.500	300/2.07	102 4.01
150X80 6X3	168.3X88.9 6.625X3.500	300/2.07	102 4.01
150X100 6X4	168.3X114.3 6.625X4.500	300/2.07	102 4.01
150X80 6X5	168.3X139.7 6.625X5.500	300/2.07	102 4.01
200X80 8X3	219.1X88.9 8.625X3.500	300/2.07	127 5
200X100 8X4	219.1X114.3 8.625X4.500	300/2.07	127 5
200X125 8X5	219.1X139.7 8.625X5.500	300/2.07	127 5
200X150 8X6	219.1X165.1 8.625X6.500	300/2.07	127 5
200X150 8X6	219.1X168.3 8.625X6.625	300/2.07	127 5

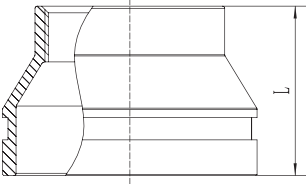
**XGQT5S****Threaded  
Concentric  
Reducer**

Nominal Size mm/in	Pipe O.D mm	Working Pressure PSI/Mpa	Dimensions L mm	Certificate
50X25/2X1	60.3X33.7	300/2.07	64	FM UL
50X32/2X1¼	60.3X42.4	300/2.07	64	FM UL
50X40/2X1½	60.3X48.3	300/2.07	64	FM UL
65X25/2½X1	73.0X33.7	300/2.07	64	FM UL
65X32/2½X1¼	73.0X42.4	300/2.07	64	FM UL
65X40/2½X1½	73.0X48.3	300/2.07	64	FM UL
65X50/2½X2	73.0X60.3	300/2.07	64	FM UL
65X25/3ODX1	76.1X33.7	300/2.07	64	FM UL
65X32/3ODX1¼	76.1X42.4	300/2.07	64	FM UL
65X40/3ODX1½	76.1X48.3	300/2.07	64	FM UL
65X50/3ODX2	76.1X60.3	300/2.07	64	FM UL
80X25/3X1	88.9X33.7	300/2.07	64	FM UL
80X32/3X1¼	88.9X42.4	300/2.07	64	FM UL
80X40/3X1½	88.9X48.3	300/2.07	64	FM UL
80X50/3X2	88.9X60.3	300/2.07	64	FM UL
80X65/3X2½	88.9X73.0	300/2.07	64	FM UL
80X65/3X3OD	88.9X76.1	300/2.07	64	FM UL
100X25/4¼ODX1	108.0X33.7	300/2.07	76	FM UL
100X32/4¼ODX1¼	108.0X42.4	300/2.07	76	FM UL
100X40/4¼ODX1½	108.0X48.3	300/2.07	76	FM UL
100X50/4¼ODX2	108.0X60.3	300/2.07	76	FM UL
100X65/4¼ODX3OD	108.0X76.1	300/2.07	76	FM UL
100X80/4¼ODX3	108.0X88.9	300/2.07	76	FM UL
100X25/4X1	114.3X33.7	300/2.07	76	FM UL
100X32/4X1¼	114.3X42.4	300/2.07	76	FM UL
100X40/4X1½	114.3X48.3	300/2.07	76	FM UL
100X50/4X2	114.3X60.3	300/2.07	76	FM UL
100X65/4X2½	114.3X73.0	300/2.07	76	FM UL
100X65/4X3OD	114.3X76.1	300/2.07	76	FM UL
100X80/4X3	114.3X88.9	300/2.07	76	FM UL
125X25/5½ODX1	139.7X33.7	300/2.07	89	FM UL
125X32/5½ODX1¼	139.7X42.4	300/2.07	89	FM UL
125X40/5½ODX1½	139.7X48.3	300/2.07	89	FM UL
125X50/5½ODX2	139.7X60.3	300/2.07	89	FM UL
125X65/5½ODX3OD	139.7X76.1	300/2.07	89	FM UL
125X80/5½ODX3	139.7X88.9	300/2.07	89	FM UL
125X100/5½ODX4	139.7X114.3	300/2.07	89	—



## XGQT5S Threaded Concentric Reducer

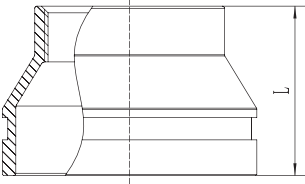

Nominal Size mm/in	Pipe O.D mm	Working Pressure PSI/Mpa	Dimensions L mm/in	Certificate
150X25/6¼ODX1	159.0X33.7	300/2.07	89	FM UL
150X32/6¼ODX1¼	159.0X42.4	300/2.07	89	FM UL
150X40/6¼ODX1½	159.0X48.3	300/2.07	89	FM UL
150X50/6¼ODX2	159.0X60.3	300/2.07	89	FM UL
150X65/6¼ODX3OD	159.0X76.1	300/2.07	89	FM UL
150X80/6¼ODX3	159.0X88.9	300/2.07	89	FM UL
150X25/6½ODX1	165.1X33.7	300/2.07	102	FM UL
150X32/6½ODX1¼	165.1X42.4	300/2.07	102	FM UL
150X40/6½ODX1½	165.1X48.3	300/2.07	102	FM UL
150X50/6½ODX2	165.1X60.3	300/2.07	102	FM UL
150X65/6½ODX3OD	165.1X76.1	300/2.07	102	FM UL
150X80/6½ODX3	165.1X88.9	300/2.07	102	FM UL
150X100/6½ODX4	165.1X114.3	300/2.07	102	—
150X125/6½ODX5½OD	165.1X139.7	300/2.07	102	—
150X25/6X1	168.3X33.7	300/2.07	102	FM UL
150X32/6X1¼	168.3X42.4	300/2.07	102	FM UL
150X40/6X1½	168.3X48.3	300/2.07	102	FM UL
150X50/6X2	168.3X60.3	300/2.07	102	FM UL
150X65/6X2½	168.3X73.0	300/2.07	102	—
150X65/6X3OD	168.3X76.1	300/2.07	102	FM UL
150X80/6X3	168.3X88.9	300/2.07	102	FM UL
200X25/8X1	219.1X33.7	300/2.07	127	FM UL
200X32/8X1¼	219.1X42.4	300/2.07	127	FM UL
200X40/8X1½	219.1X48.3	300/2.07	127	FM UL
200X50/8X2	219.1X60.3	300/2.07	127	FM UL
200X65/8X3OD	219.1X76.1	300/2.07	127	FM UL
200X80/8X3	219.1X88.9	300/2.07	127	FM UL
200X100/8X4	219.1X114.3	300/2.07	127	FM UL

## ANSI heavy hex nut

1. Material: SAE J995 2
2. Thread: ANSI B 1.1-1982 Class 2B
3. Surface Treatment: Zinc electroplated per ASTM B633 Class FE/ZN5 TYPE III, Thickness 5 um per class SC1

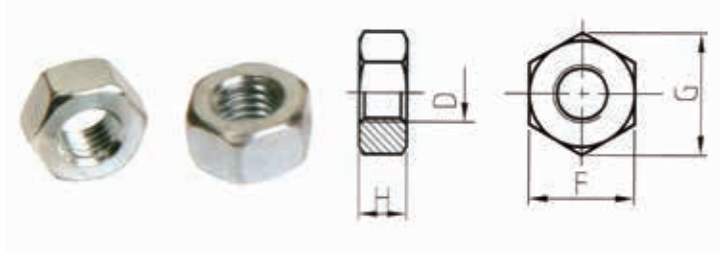

d	F		G		H	
	Min	Mar	Min	Mar	Min	Mar
3/8-16UNC	16.99	17.47	19.38	20.17	8.66	9.57
1/2-13UNC	21.59	22.22	24.61	25.65	11.78	12.80
5/8-11UNC	26.19	26.97	29.85	31.16	14.90	16.02
3/4-10UNC	30.78	31.75	35.10	36.65	18.03	19.25
7/8-9UNC	35.41	36.53	40.36	42.16	21.16	22.48

## Metric heavy hex nut

1. Material: ISO 898-2: 1992 /GB/T 3098.2-2000 Class 8
2. Thread: ISO 261, tolerance 6h for M10&M12, 7h for M16 and above
3. Surface Treatment: Zinc electroplated followed by a yellow chromate dip per ISO 2081 FE/ZN5, ISO4520 CLASS 1A

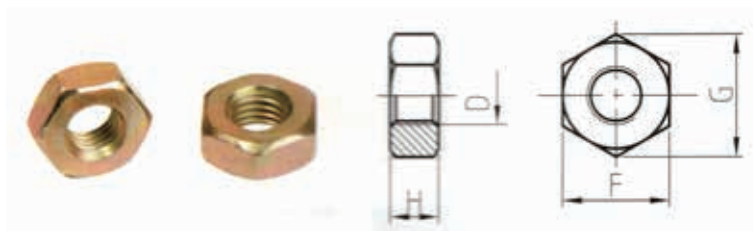

d	F		G	H	
	Min	Mar	Min	Min	Mar
M10	15.73	16.0	17.7	8.0	8.4
M12	21.16	22.0	23.9	9.34	10.0
M16	23.16	24.0	26.17	14.1	15.9
M20	29.16	30.0	32.95	16.9	19.0
M22	33.0	34.0	37.29	18.1	20.2

## Hexagon Flange Nut

Dimension according to DIN6923

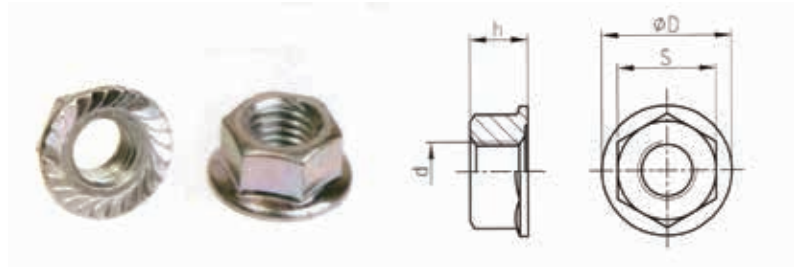

d	F		G	H	
	Min	Mar	Min	Min	Mar
M8	12.3	13	17.9	7.6	8
M10	14.73	15.0	21.8	9.64	10
M12	17.73	18.0	26.0	11.57	12.0

## ANSI Oval Neck Track Bolt

1. Material: SAE J429.5
- 2.Thread: UNC thread per ANSI B 1.1 Class 2A
- 3.Surface Treatment: Sliver chromate electroplated per ASTM B633 Class FE/ZN5 TYPE III, Thickness 5 um per class SC1

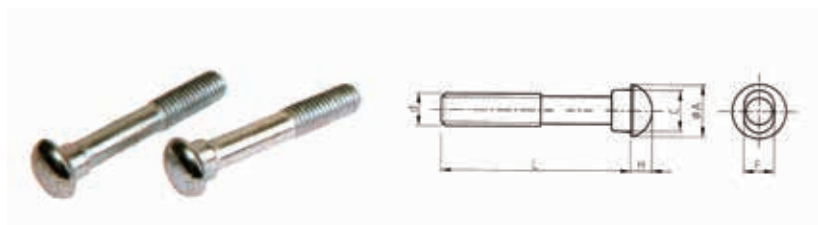

d	A	C	F	F	L
3/8-16UNC	19	13.9	9.50	6.0	55/70
1/2-13UNC	22.5	16	12.70	8.0	70/75
5/8-11UNC	27.4	19.8	15.90	10.0	80/85/105
3/4-10UNC	32.5	26.2	19.05	12.0	115/120
7/8-9UNC	37.7	28.8	22.20	14.0	125/140



## Metric Oval Neck Track Bolt

1. Material: ISO 898-2: 1992 /GB/T 3098.2-2000 Class 8.8
2. Thread: ISO metric thread per ISO 261, tolerance 6h
3. Surface Treatment: Yellow chromate electroplated per ISO 2081 FE/ZN5, ISO4520 CLASS 1A



d	A	C	F	F	L
M10	18.5	13.5	9.5	5	55/57/63/70/89
M12	23.5	17.5	12.3	8	70/76/82/89/108
M16	29.5	20.5	15.7	10	85/89/95/108
M20	38	27	18.3	12.5	110/115
M22	42.2	31	21.4	14	125/140/150

## GASKET DATA



Gasket	Name	Temperature Range	General Service Recommendations	Color Mark
E	EPDM	-34~+110°C (-30~+230°F)	Recommended for hot water service within the specified temperature range plus a variety of dilute acids, oil-free air and many chemical services. UL classified in accordance with ANSI/ NSF 61 or cold+86°F(+30°) and hot +180°F(+82°C) potable water service. Not recommended for petroleum service	Green Strip
D	NITRILE	-29~+82°C (-20~+180°F)	Recommended for petroleum products, air with oil vapors, vegetable and mineral oils within the specified temperature range. Not recommended for hot water services.	Orange Strip
S	SILICON	-40~+177°C (-40~+350°F)	Recommended for high temperature dry air and some high temperature chemical products.	White

## Hole diameter of pipe

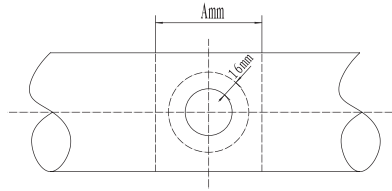

Run Nominal Size mm/in	Outlet Nominal Size mm/in	Hole Dia. +3.2,0/+0.13,0 mm/in
25 1"/33.7	15 1/2	24 0.94
	20 3/4	
32 1 1/4"/42.4	15 1/2	30 1.18
	20 3/4	
	25 1	
40 1 1/2"/48.3	15 1/2	30 1.18
	20 3/4	
	25 1	
50 2"/60.3	15 1/2	30 1.18
	20 3/4	
	25 1	38 1.50
	32 1 1/4	
	40 1 1/2	
65 2 1/2"/73.0 76.1	25 1	38 1.50
	32 1 1/4	
	40 1 1/2	51 2
	50 2"/60.3	

Nominal Size mm/in	Pipe OD mm/in	Hole Dia. +3.2,0/+0.13,0 mm/in
80 3"/88.9	25 1	38 1.50
	32 1 1/4	46 1.81
	40 1 1/2	51 2
	50 2"/60.3	61 2.40
	65 2 1/2	61 2.40
100 108 4"/114.3	25 1	38 1.50
	32 1 1/4	46 1.81
	40 1 1/2	51 2
	50 2"/60.3	61 2.40
	65 2 1/2	81 3.18
	80 3	89 3.5
125 133 139.7 5"/141.3	25 1	38 1.50
	32 1 1/4	46 1.81
	40 1 1/2	51 2
	50 2"/60.3	61 2.40
	65 2 1/2	81 3.18
	80 3	89 3.5
	100 4	114 4.48

Nominal Size mm/in	Pipe OD mm/in	Hole Dia. +3.2,0/+0.13,0 mm/in
150 159 165.1 6"/168.3	25 1	38 1.50
	32 1 1/4	46 1.81
	40 1 1/2	51 2
	50 2"/60.3	61 2.40
	65 2 1/2	81 3.18
200 8"/219.1	80 3	89 3.5
	100 4	114 4.48
	25 1	38 1.50
	32 1 1/4	46 1.81
	40 1 1/2	51 2
	50 2"/60.3	61 2.40
	65 2 1/2	81 3.18
	80 3	89 3.5
100 4	114 4.48	

The outside surface of the pipe within 16mm from the hole must be clean and smooth.



## Installation Instruction For Rigid & Flexible Coupling



1. Install the gasket into the gasket pocket, as shown above. Press the gasket along the full circumference to ensure that it fully seats in the gasket pocket. **DO NOT LUBRICATE THE GASKET.**

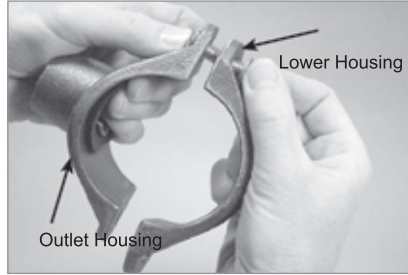

2. Insert a bolt into the outlet housing and lower housing, and thread a nut loosely onto the bolt (nut should be flush with end of bolt) to allow for the "swing-over" feature, as shown above.



3. Install the outlet housing onto the pipe by centering the locating collar in the hole. To check for proper engagement, slide the outlet housing back and forth while pushing down. A properly positioned outlet housing can be moved only a small amount in any direction.

3a. Rotate the lower housing around the pipe, while holding the outlet housing in place to make sure the locating collar remains seated properly in the hole.



4. Insert the other track bolt into the outlet housing and lower housing. Install the nut finger-tight.

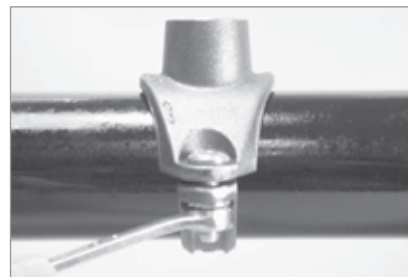

5. Tighten the nuts evenly to an approximate torque value of 20 ft-lbs/27.1 N·m to ensure proper gasket compression. **NOTE:** To avoid over-tightening the nuts, use a wrench with a maximum length of 8 inches/200 mm. **DO NOT** over-tighten the nuts.

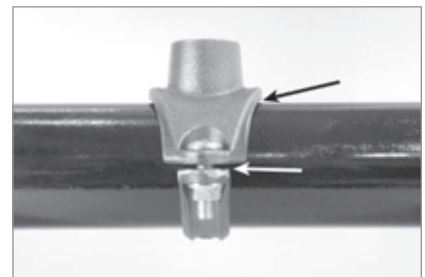

6. The outlet housing, near the gasket, should not make metal-to-metal contact with the pipe. In addition, a small gap is expected between the outlet housing and the lower housing, as shown above.

### Caution

Proper torque of bolts is required to obtain specified performance.

-Over torquing the bolts may result in damage to the bolt and /or casting which could result in pipe joint separation.

-Under torquing the bolts may result in lower pressure retention capabilities, lower bend load capabilities, joint leakage and pipe joint separation. Pipe joint separation may result in significant property damage and serious injury.

### Specified Bolt Torque

#### ANSI BOLTS

Bolt Size	Specified Bolt Torque	
	Lbs-Ft.	/N.m
Inch		
3/8	30-45	40-60
1/2	80-100	110-135
5/8	100-130	135-175
3/4		
7/8		

## Installation Instruction for Mechanical Tees/Crosses, Side Outlets(Rolled type and Threaded type), including Model XGQT 3,3S,3U.

Side outlet (mechanical cross) can be directly used to connect the branch pipes with the main steel pipe. Firstly, to open the hole with hole-cutting machine on steel pipes ,and clip the side outlet(mechanical cross)into the hole, around which are sealed by the gasket rings .Side outlet (mechanical cross)are categorized as threaded style and Grooved style. When be connected ,the threaded mechanical tee or mechanical cross should be applied with some compacting paint on it's outer screw thread ,and then roll thread around it to ensure the sealing performance of threaded joint.

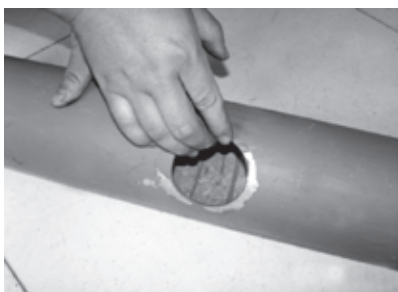

1. Check the hole pickles.



2. Spread lubricant on gasket ring.



3. Put gasket seal in the Mechanical Tee.



4. Install the Mechanical Tee in the hole.



5. Install the bottom piece on the upper one of Mechanical Tee.



6. Secure the nuts and bolts of side outlet from both side.





## Installation Instruction for Flange, including Model XGQT08

Flange adaptor(Flange adaptor .threaded flange. flange )can be used for the transitional connection between the grooved pipe and the equipment & valves with flanges .The diameter ,location and measurement of the bolt hole on Flange adaptor are matching the bolts of international standards (GB9114.9115.9116.9119.9123-88)



1. Before installation, whether the groove meet the standard should be checked and then wipe away the pickles, iron rust, greasy dirt on gasket ring and pipe.



2. Assemble one part of flange on the pipe, and keep it in the groove of pipe



3. Put another part of flange in the groove, screw the bolts and nuts averagely on the two parts



4. Check the gasket to keep the availability in any situation, spread lubricant on surface of gasket.



5. Assemble gasket in the pipe OD and flange groove, to keep the gasket in right orientation.



6. Secure the bolts and refer to Table 5 for Bolt-Torque.

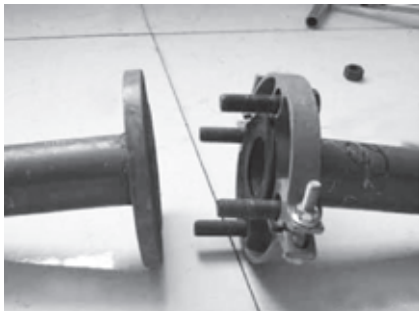

7. Insert standard bolts in bolt holes.



8. Insert standard bolts in the mated flange holes and screw nuts on them.

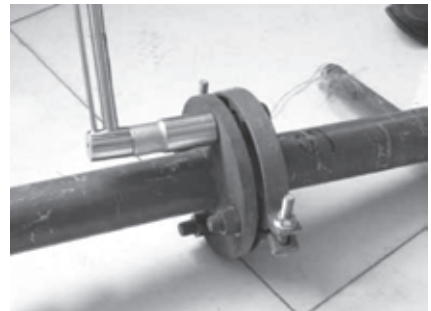

9. Secure the nuts and refer to Table 5 for Bolt-Torque.

## Rigid Coupling

1. The Tongue & Groove mechanism in combination with a slightly shortened key diameter provides a mechanical and frictional interlock resulting in a rigid joint which reduces undesired angular movement.
2. The build-in teeth on the coupling grip the groove shoulder and serve to reduce linear movement.
3. The Tongue & Groove mechanism features a slight offset at the foot of the coupling halves which serve to protect the gasket from exposure.
4. With the Tongue & Groove style coupling no metal-to-metal contact of the bolt pads is required you will normally see a 1.6mm to 3.2mm gap between the bolt pads when installed.

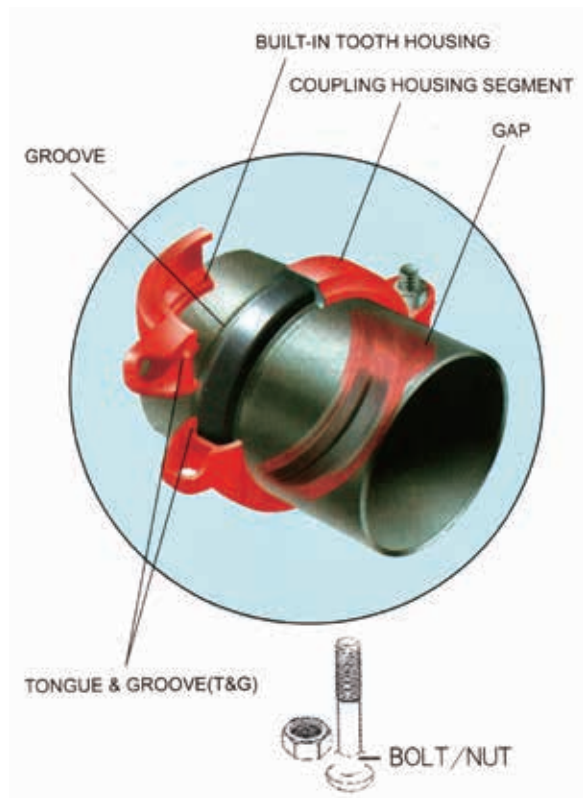

## Mechanical Tee Connection:

The Mechanical tee provide for a fast and easy grooved or threaded branch outlet and eliminate the need for welding or the use of a reducing tee and couplings. Simply cut a hole to the specified size at the expected location and fasten the mechanical tee to the pipe with the nuts and bolts provided. As the housing bolts are tightened, the pressure responsive gasket forms a leak-tight seal.

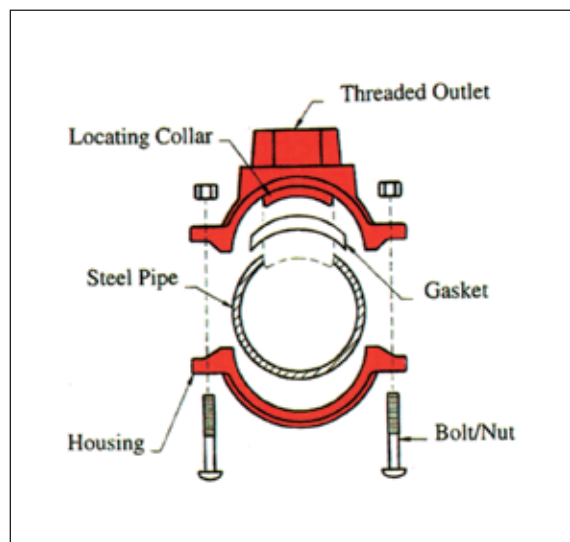

## Flexible Coupling

1.A flexible coupling accommodates pipe deflection and non-alignment as below: if nominal diameter < DN200, deflection angle is  $\geq 1$  degree; if nominal diameter  $\geq$  DN200, deflection angle is  $\geq 0.5$  degree but  $< 1$  degree

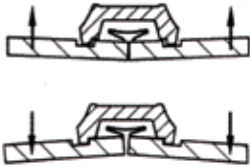

2.The C-shaped rubber gasket provides excellent self-sealing capabilities in both low and high pressure service as well as under certain vacuum conditions

3.The design and construction of the coupling with elastomeric gaskets can provide significant noise and vibration absorption as well as seismic stress.

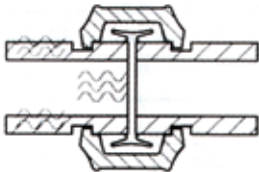

4.With the removal of just a few bolts you can easily access the system for cleaning maintenance changes or system expansion.

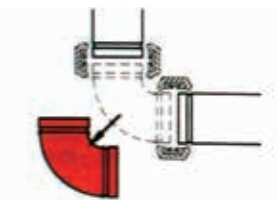

5.Coupling is non-directional and pipe can be rotated 360 degree during installation.

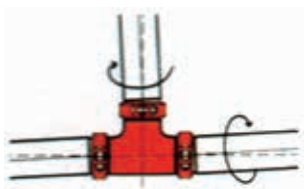

6.Coupling keys engage the full circumference of the grooves and provide significant pressure and end load restraint against pipe movement from internal and external forces.

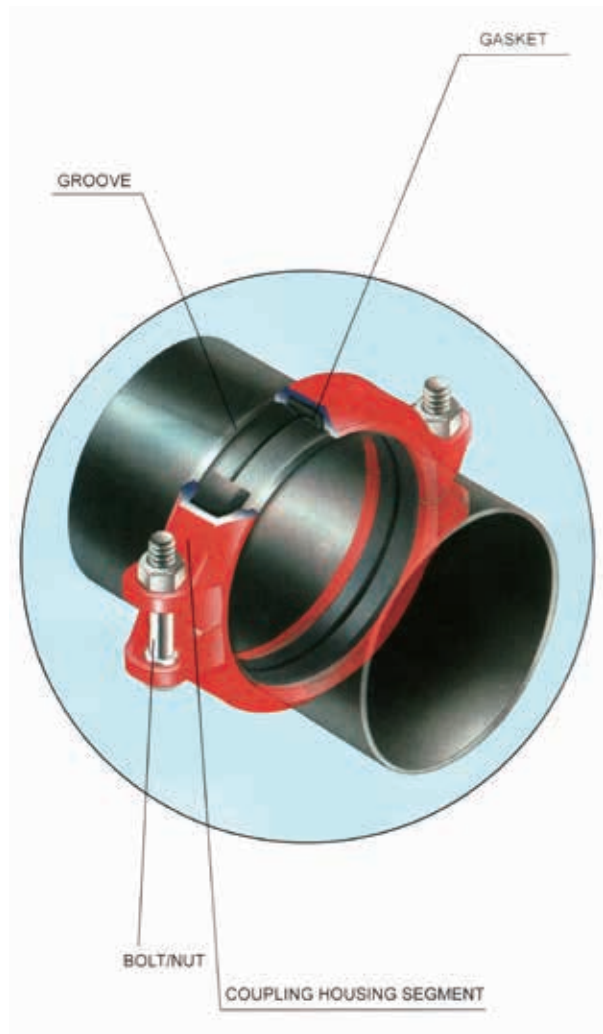
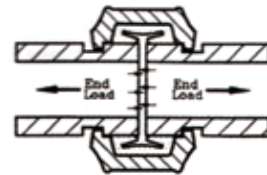

## Typical Test Diagram

### Hydrostatic Test

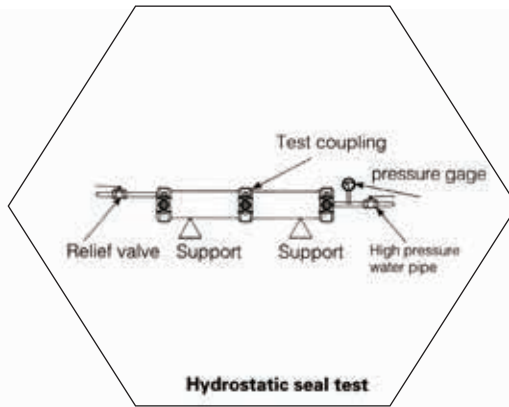
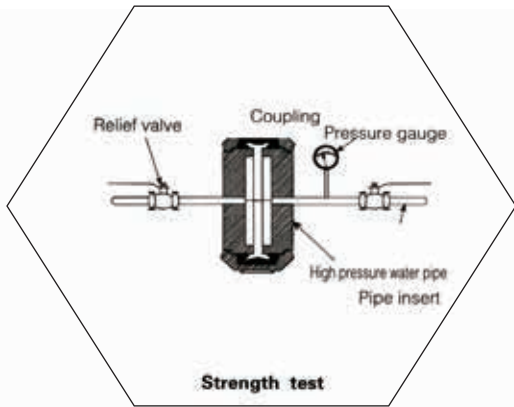

### Coupling bending moment test

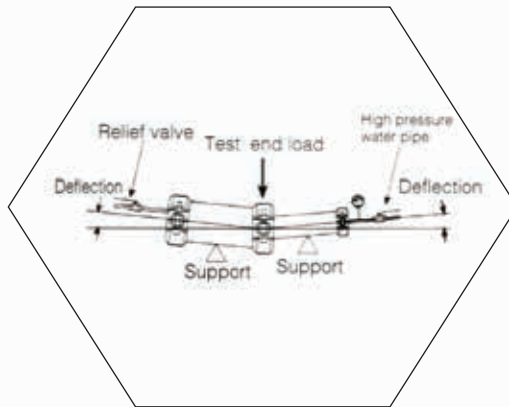
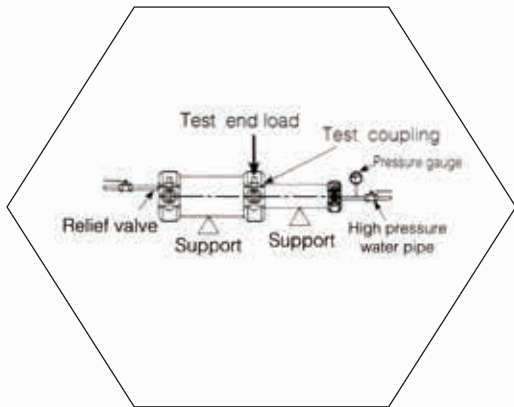

### Sideoutlet bending moment test

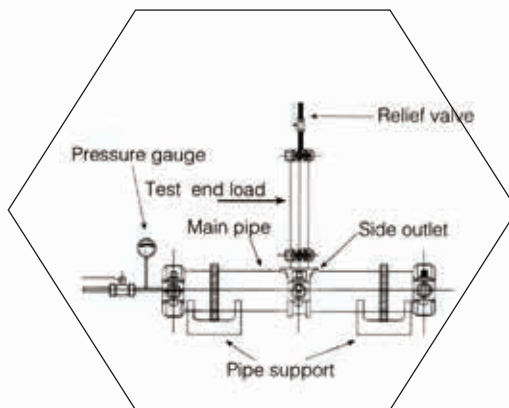
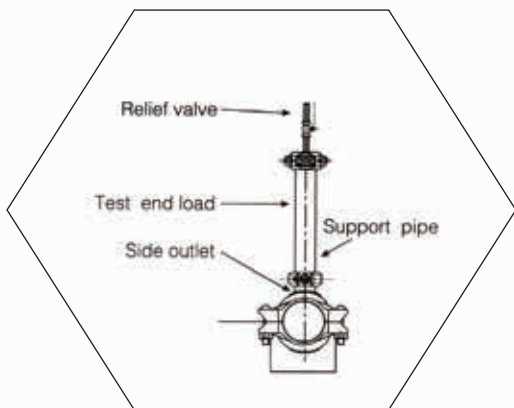



## Engineering Test

No.	Test	Standard
1	Vacuum Test	Grooved couplings, grooved reducing couplings, grooved split flanges, mechanical tees, and plain end couplings shall be able to withstand the effects of vacuum conditions encountered when sprinkler systems are drained. Samples of each nominal size and style of gasket coupling and fitting shall be subjected to an internal vacuum of 25 inHg(85 kpa) for a duration of 5 minutes. Following the vacuum test, the test assembly shall be pneumatically pressurized from zero to 50 psi (345kPa) while submerged in a water bath. There shall be no leakage or permanent deformation as a result of this test.
2	Hydrostatic Strength Test	All items shall be able to withstand an internal hydrostatic pressure equal to three-five times the rated working pressure without cracking, rupture, or permanent distortion. The test shall be conducted for a duration of 1 minute. (Test Sizes≤6", Five time; 8" -10", 4time; ≥12", 3times)
3	Air Leakage Test	The coupling assembly shall be pressurized with air to 3 bar +0.5/-0 bar. The assembly shall be immersed in water to establish that there is no visible leakage.
4	Moment Test	The moment resistance shall be demonstrated while the test assembly is internally pressurized to the rated working pressure. Then a force was applied to the test assembly. There shall be no leakage, cracking, or fitting or coupling pull-off as a result of this test.
5	Hot Gasket Test	Standard gaskets shall be assembled to short lengths of pipe, and subjected to 275°F(135°C)for a duration of 45 days. After exposure, the test assembly shall be submerged in a water bath and subjected to an air under water leakage test from zero to 50 psi(0-345 kpa) in order to evaluate for leakage. After the air under water testing is completed, the test assembly shall be disassembled and the gasket shall not crack when squeezed together from any two diametrically opposite points, or twisted into a figure-eight shape. The gasket shall then be visually inspected for signs of cracking, tearing, or excessive degradation as a result of this test.
6	Cold Gasket Test	The low temperature exposure shall consist of -40°F(-40°C)air exposure for 4 days. After exposure, the assembly while submerged in -40°F(-40°C)antifreeze, shall be pneumatically pressurized from 0 to 50 psi(0-345 kpa). No leakage shall occur. The assembly shall then be allowed to warm to ambient temperature and then be disassembled. The gasket, after removal from the assembly, shall not crack when squeezed together from any two diametrically opposite points, or twisted into a figure eight shape.
7	Flame Test	The test shall be conducted in a room free from air draught. The test joint is mounted, U-belt on the test apparatus and filled with water. The angle corresponds to the angle documented as a result of the test subsequently the test joint is drained. The fuel pan is placed centrally below the pipe joint. Fuel is filled into the pan and the fuel is ignited. Burning time 5 min for nominal diameters<DN100,8 min for nominal diameters≥DN100 For reducer couplings the dimension of the smaller nominal diameter shall apply for the determination of the burning time. The flame shall be extinguished immediately once the burning time has expired (5 min or 8 min) and the test joint shall be cooled down. For cooling the test joint is immediately sprayed with water until steam formation is no longer visible, but at least for 3 min. The test joint is then filled completely with water and exposed to a test pressure which corresponds to the maximum permissible pressure and is checked visibly for leaks. Water may leak in form of drops, however, not in form of flowing water or a water spray. The test joint is then pressure relieved (force and internal pressure).
8	Cycling Pressure Resistance (Water Hammer Test)	Prior to the cycling, assemblies shall be subjected to a hydrostatic strength test to the rated working pressure, 175 psi (1205 kpa) minimum, for a duration of 5 minutes, without leakage or cracking. Assemblies shall then be subjected to 20,000 cycles from zero pressure to the rated working pressure, 175 psi (1205 kpa) minimum. After cycling, the test assembly shall be tested hydrostatic strength and maintain 5 minutes without leakage and cracking.
9	Friction Loss Determination	The construction and installation of the coupling or fitting shall be such that obstruction to the passage of water through the coupling or fitting body is minimal. The loss in pressure through the coupling or fitting shall not exceed 5.0 psi(35 kpa) at a flow producing a velocity of 20 ft/s (6.1 m/s) in schedule 40 steel pipe of the same nominal diameter as the coupling or fitting.
10	Leakage Test- Assembly without Gasket	Leakage from a gasket-less coupling assembly or fitting shall not exceed that of an operating sprinkler head whose discharge coefficient (K-factor) is 5.3 to 5.8 gal/min(psi) <sup>1/2</sup> [76-84L/min(bar) <sup>1/2</sup> ]. This test is for nominal pipe sizes normally associated with over-head piping, less than or equal to 12 in. NPS(300 mm).
11	Torsion test	This test relates to pipe joints ≤ DN40 only. The test joint is filled with water and exposed once to the maximum permissible pressure and is then pressure relieved again. Subsequently the test joint is fixed on one pipe end and an increasing torque is applied to the other pipe end. At the pressure-less test joint the pipe joint shall be able to transmit a torque of up to 80Nm from one pipe end to the other pipe end without any torsion of the pipe ends against each other.
12	Flexibility Test for Flexible Fittings	With the assembly pressurized to its rated pressure, a bending moment is to be applied to deflect the joint to the maximum angle specified by the manufacturer, while not less than 1 degree for nominal pipe diameters less than 8 inches (203.3mm) or 0.5 degrees for 8 inches (203.2mm) and larger. Observations are to be made for leakage or pipe damage.
13	Seismic Evaluation	In order to evaluate the use of grooved couplings in earthquake zones 50-500 years, test assemblies utilizing flexible couplings and short lengths of steel pipe, in the same nominal size, will be subjected to cyclic testing. The test will deflect the assembly to the manufacturer's maximum recommended angle in the forward and reverse direction for a total 15 cycles with the internal pressure equal to the rated working pressure. There shall be no leakage, cracking, or rupture as a result of this test.
14	Lateral Displacement	The coupling shall not leak during any of the tests, within the manufacturer's stated limitations for angular deflection or lateral displacement of associated pipe work.
15	Hydrostatic fluctuation pressure test	The coupling assembly shall be pressurized with water to a gauge pressure of 10 bar±1bar for 2 min, +30s/-0s to establish a datum. The assembly shall then be drained before being subjected to the greatest vacuum attainable to a maximum of 600mm a/mercury or -0.8 bar +0 bar/-0.1 bar for 2 min +30s/-0s, and allowed to return to atmospheric pressure in not less than 5s. The assembly shall then be pressurized with water to 10 bar±1 bar for 2 min +30s/-0s. The assembly shall be examined for leakage throughout the test. The relative movement of each pipe shall be recorded at the greatest vacuum and at each pressure. There shall be no leakage.
16	Fire Test	If a gasketed pipe coupling or fitting employs non-ferrous materials for its substantial structural components, or if in the judgment of FM Approval, the design is otherwise suspect with respect to fire resistance, a fire test shall be conducted. A representative size assembled joint without a gasket shall be exposed to a 1000°F(538°C) fire environment for 5 minutes. The assembly shall be dry for the duration of this exposure. Immediately after the expose, a water flow shall be introduced through the joint and sustained until the assembly is cool to the touch . No cracking or distortion of any component of the coupling or fitting shall occur . The coupling or fitting shall then be disassembled and the gasket installed. After the joint shall be hydrostatically tested, as described in to the hydrostatic test.

# WFHSH

## Shandong Zhihua Pipe Industry Co., Ltd

Address: Zhangjia Village, Fangan Subdistrict, Fangzi District,  
Weifang City, Shandong Province, China Zip Code: 262113

Tel: +86-536-7929119

Fax: +86-536-7952077

E-mail: [trade@wfzihua.com](mailto:trade@wfzihua.com) [weifangfangan@163.com](mailto:weifangfangan@163.com)

Website: [www.wfzihua.com](http://www.wfzihua.com)

